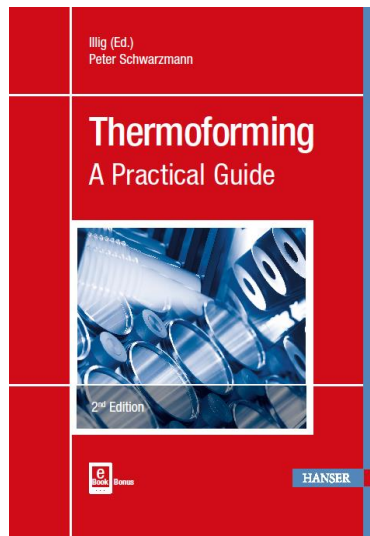


# HANSER



## Sample Pages

# Thermoforming

**Illig/Peter Schwarzmann**

ISBN (Book): 978-1-56990-708-5

ISBN (E-Book): 978-1-56990-709-2

**For more information and to order visit**

[www.hanserpublications.com](http://www.hanserpublications.com) (in the Americas)

[www.hanser-fachbuch.de](http://www.hanser-fachbuch.de) (outside the Americas)

© Carl Hanser Verlag, München

# Contents

<b>Preface to the 2nd English Edition</b> .....	<b>V</b>
Preface to the 3rd German Edition .....	V
Preface to the 2nd German Edition .....	V
Preface to the 1st German Edition .....	VI
<b>1 Introduction</b> .....	<b>1</b>
<b>2 Basic principles and terminology in thermoforming</b> .....	<b>5</b>
2.1 Process sequence .....	5
2.2 Positive and negative forming .....	6
2.3 Vacuum and pressure forming .....	8
2.3.1 Differences between vacuum and pressure forming .....	8
2.3.2 Application for pressure forming .....	9
2.4 Forming pressure, contour-molding pressure, and contour definition	10
2.5 Preblow, presuction, pressure equalisation, air injection .....	12
2.6 Chill marks and blemishes .....	13
2.6.1 Chill marks on positively formed parts .....	14
2.6.2 Chill marks on negatively formed parts .....	17
2.6.3 Causes of chill marks .....	19
2.6.4 Options for reducing chill marks .....	19
2.6.5 Results of chill mark formation .....	20
2.6.6 Use of typical wall-thickness distribution in chill marks with snaps on clamshell packages .....	21
2.6.7 Conclusions with regard to chill marks .....	22
2.6.8 Blemishes and markings .....	22
2.7 Wrinkle formation during thermoforming .....	23
2.7.1 Wrinkle formation sequence in positive forming .....	24
2.7.2 Wrinkle formation in negative forming .....	26
2.7.3 Wrinkle formation on surfaces .....	27

2.8	The tool set	28
2.9	Forming surface, intake surface, clamped edge	29
2.10	Downholder, upholder	30
2.11	Forming and stretching ratio	31
2.12	Draft angles	32
2.13	Vent cross-sections	33
2.14	Calculating wall thickness	33
<b>3</b>	<b>Semi-finished thermoplastic materials</b>	<b>35</b>
3.1	Elements and structure of thermoplastic materials	35
3.2	Absorption of moisture in semi-finished product	36
3.3	Response during heating	37
3.4	Expansion and sag	39
3.5	Forming temperature ranges	41
3.6	Friction properties in thermoforming	42
3.7	Contour definition	44
3.8	Molding shrinkage in thermoforming	45
3.9	Free shrinkage of semi-finished products	51
3.10	Effects of stresses in the extruded semi-finished product	55
3.11	Electrostatic charge	59
3.12	The visco-elastic properties of thermoplastic materials during thermoforming	60
3.13	Properties during cooling	62
3.14	Tolerances of semi-finished products	62
3.15	Manufacturing process for thermoplastic semi-finished products	63
3.16	Table for the thermoformer	67
3.17	Thermoplastics for thermoforming	71
3.17.1	Polystyrene (PS)	71
3.17.2	High-impact polystyrene (HIPS)	72
3.17.3	Styrene butadiene styrene block copolymer (SBS)	73
3.17.4	Oriented polystyrene (OPS)	74
3.17.5	Acrylonitrile butadiene styrene copolymer (ABS)	75
3.17.6	Acrylic styrene acrylonitrile copolymer (ASA)	76
3.17.7	Styrene acrylonitrile copolymer resin (SAN)	77
3.17.8	Polyvinylchloride (PVC-U)	78
3.17.9	Polyethylene, high-density (PE-HD)	79

3.17.10	Polypropylene (PP): Detailed presentation	80
3.17.11	Extruded polymethyl methacrylate (PMMA ex)	95
3.17.12	Cast polymethyl methacrylate (PMMA g)	96
3.17.13	Polycarbonate (PC)	98
3.17.14	Polyamide (PA)	99
3.17.15	Polyethylene terephthalate, PET: Detailed presentation	100
3.17.16	Polysulfone (PSU)	107
3.17.17	EPE and EPP foamed materials	108
3.17.18	Bioplastics in thermoforming	109
3.17.18.1	Biodegradable plastics from renewable raw materials	110
3.17.18.2	Non-degradable bioplastics	115
3.17.19	Multilayer, barrier and composite semi-finished materials	116
3.17.20	Other materials	125
3.17.21	Brand names	126
<b>4</b>	<b>Heating technology in thermoforming</b>	<b>127</b>
4.1	Radiant heaters	127
4.1.1	Heat-transfer concept with infrared radiation	127
4.1.2	Heat quantity transferred by radiation	129
4.1.3	Homogeneous heating with radiant heaters	135
4.1.4	Ceramic, quartz and halogen heaters in comparison	142
4.2	Reproducibility of heating results in radiant heaters	145
4.2.1	Assessing reproducibility	145
4.2.2	Compensation for uncontrollable external influences on the heating process	149
4.2.3	Power control and temperature control in heaters	150
4.3	Contact heaters	151
4.4	Convection heaters	153
4.5	Minimum heating time, effective heating time and residence time	154
4.5.1	Effect of heating time on thermoforming response	154
4.5.2	Positive effect of residence time	155
4.5.3	Negative effect of residence time	155
<b>5</b>	<b>Heaters in sheet-processing machines</b>	<b>157</b>
5.1	Basic principles of heating with isothermal control	158
5.1.1	Technical terminology	158
5.1.2	Details regarding temperature control with ceramic heat elements	161
5.1.3	Advantages of heating systems with closed-loop control provided by pilot heater elements	162

5.2	Joystick distribution of the heating pattern .....	162
5.3	Multi-positional control .....	164
5.4	Heater-element temperature control with superimposed position in percent .....	166
5.5	IR-sensor (pyrometer) for monitoring temperature and closed-loop control of heaters .....	167
<b>6</b>	<b>Heaters in automatic roll-fed machines .....</b>	<b>169</b>
6.1	General information .....	169
6.2	Heaters regulated by pilot heater elements in automatic roll-fed machines .....	170
6.2.1	Heater with longitudinal control of row temperatures .....	170
6.2.2	Heater panel with temperature control governing total array	171
6.2.3	Heater with transverse row control .....	172
<b>7</b>	<b>Heating multicoloured and preprinted materials using IR heaters .....</b>	<b>173</b>
7.1	General information .....	173
7.2	Selection of infrared heaters .....	173
<b>8</b>	<b>Thermoforming process on sheet-processing machines ....</b>	<b>177</b>
8.1	Positive forming .....	178
8.1.1	Positive forming with mechanical prestretching .....	178
8.1.2	Positive forming with preblow .....	179
8.1.3	Positive forming with preblow against a board .....	182
8.1.4	Positive forming with presuction and unreeling of the blister on the mold .....	183
8.1.5	Positive forming with presuction in a vacuum/pressure box .	184
8.1.6	Application of corner blow nozzles with positive forming ...	185
8.2	Negative forming .....	186
8.2.1	Negative forming without plug-assist tool .....	186
8.2.2	Negative forming with plug-assist tool .....	187
8.3	Positive-negative forming .....	189
8.4	Twin-chamber method (3K method) .....	190
8.5	Twinsheet forming .....	191
8.5.1	Universal rules for twinsheet forming on series twinsheet forming machines .....	192
8.5.2	Twinsheet forming process, UA machine with hand loading .	193
8.5.3	Machine versions for twinsheet forming .....	196

8.6	Adhesive lamination .....	198
8.6.1	General information .....	198
8.6.2	Lamination process .....	199
<b>9</b>	<b>Thermoforming process on automatic roll-fed machines, punching station with blade cut .....</b>	<b>203</b>
9.1	Concept of process sequence at the forming station .....	203
9.2	Machine equipment with an effect on the forming procedure .....	207
9.3	Selecting the correct forming procedure and tool configuration .....	208
9.4	Information regarding ways to influence wall thickness distribution .	209
<b>10</b>	<b>Thermoforming process on automatic roll-fed machines, forming and punching tools with shear cuts .....</b>	<b>215</b>
10.1	Geometrical motion patterns of the forming and punching station ...	215
10.2	The special features of the mechanical cam control .....	217
10.3	Flow chart for a forming station using forming and punching tool with negative forming .....	218
10.3.1	Forming-air reduction .....	219
10.3.2	Downholder control .....	219
10.4	Flow chart for a forming station using forming and punching tool with shear cut for positive forming .....	220
<b>11</b>	<b>Special procedures using combined forming and punching tools in automatic roll-fed machines .....</b>	<b>221</b>
11.1	Applying linings to dimensionally stable containers .....	221
11.2	Labelling in the mold (IML In-Mold Labelling) .....	223
11.3	Forming and punching tool for rimless formed parts .....	226
11.4	Thermoforming hollow-base cups .....	227
11.5	Thermoforming with mold and countermold .....	228
<b>12</b>	<b>Thermoforming transparent parts .....</b>	<b>229</b>
12.1	Generally applicable rules for forming transparent parts .....	229
12.2	Special considerations for molding with sheet-processing machines .	231
12.3	Special considerations for forming with automatic roll-fed machines .	232
12.4	Sample procedures - Production of transparent parts .....	236
12.5	Special production process for transparent parts .....	241

<b>13</b>	<b>Thermoforming preprinted materials</b> .....	<b>243</b>
13.1	General information .....	243
13.2	Determining distortion-printing image .....	246
<b>14</b>	<b>Cooling the formed parts</b> .....	<b>251</b>
14.1	The demolding temperature .....	251
14.2	Influencing factors affecting cooling times .....	252
14.3	Cooling with the mold .....	253
14.4	Cooling with air .....	253
14.4.1	Current technology for air cooling in sheet-processing machines .....	255
14.4.2	Reducing the mold temperature in conjunction with colder cooling air .....	257
<b>15</b>	<b>Demolding</b> .....	<b>261</b>
<b>16</b>	<b>Stacking parts</b> .....	<b>265</b>
16.1	General information .....	265
16.2	Stacking formed parts with changing stacking lugs .....	271
<b>17</b>	<b>Finish-processing on thermoformed parts</b> .....	<b>273</b>
17.1	Separating, cutting .....	273
17.2	Deburring .....	276
17.3	Connecting .....	276
17.4	Recycling .....	278
<b>18</b>	<b>Punching thermoformed parts</b> .....	<b>279</b>
18.1	Blade cut .....	279
18.2	Shear cut .....	286
18.3	Comparisons of blade and shear cuts .....	293
18.4	Factors affecting the punching process .....	296
18.5	Angel-hair formation .....	297
18.5.1	Reduction of angel-hair formation with blade cut .....	301
18.5.2	Reduction in angel-hair formation with shear cut in forming and punching tool .....	302
18.6	Rough-edged cuts - Die drool .....	304
18.7	Punching forces .....	306

18.8	Conclusion .....	308
18.8.1	Blade-cut tools - Punching tools for separate punching station .....	308
18.8.2	Shear-cut tools for separate punching station .....	309
18.8.3	Forming and punching tools with blade cut .....	310
18.8.4	Forming and punching tools with shear cut .....	310
18.9	Related cutting procedures .....	311
<b>19</b>	<b>Decoration and thermoforming .....</b>	<b>315</b>
19.1	Illustrations .....	320
<b>20</b>	<b>Distortion in thermoformed parts .....</b>	<b>329</b>
20.1	Demonstrations of influences on distortion .....	329
20.2	Effect of thick points .....	331
20.3	Effect of tension in the semi-finished material .....	331
20.4	Distortion in a labelled formed part .....	332
20.5	Distortion of the clamped flange on a rectangular formed part .....	332
20.6	Distortion with anisotropic contraction .....	333
20.7	Conclusion, causes of distortion .....	334
20.8	Tips and information regarding distortion .....	335
<b>21</b>	<b>Thermoforming tools .....</b>	<b>337</b>
21.1	Terminology and definitions .....	337
21.2	Materials for the forming segment .....	338
21.3	Help for the tool material and version selection .....	342
21.4	Positive or negative forming? .....	343
21.5	Design configuration of the forming surface .....	344
21.6	Processing shrinkage: Who supplies the data? .....	348
21.7	Determining the size of the material .....	349
21.8	The substructure .....	350
21.8.1	Illustrations of structural concepts for tools .....	353
21.8.2	Adjustable substructures for sheet-processing machines .....	357
21.8.3	Difference between invariable format and adjustable substructure .....	358
21.9	Design details for thermoforming tools .....	359
21.9.1	Sidewall drafts .....	359
21.9.2	Surface roughness .....	360



21.9.3	Radii	363
21.9.4	Tool venting, air-discharge cross-sections	364
21.9.5	Cavities	368
21.9.6	Materials for plug-assist tools	368
21.9.7	Plug-assist tool contours for negative forming	370
21.9.8	Plug-assist tool for positive tools	374
21.10	Tool with undercut	375
21.10.1	Demolding undercuts without detachable parts	375
21.10.2	Detachable parts (slider) for demolding undercuts	375
21.11	Tool design for flat formed parts with low stretch	376
21.12	Tools for forming transparent parts	377
21.13	Tools for twinsheet forming	379
21.14	Tools for sheet-material hinges and snap couplings	385
21.15	Forming and punching tools with shear cut in automatic roll-fed machines	391
21.16	Forming and punching tools with knife cut in automatic roll-fed machines	394
21.17	Preventative maintenance on forming tools	407
<b>22</b>	<b>Temperature control for thermoforming tools</b>	<b>411</b>
22.1	General information	411
22.1.1	Temperature control terminology	411
22.1.2	Effects of tool temperature	412
22.1.3	When is it possible to dispense with tool temperature control?	412
22.2	Temperature-control media	413
22.3	Materials for thermoforming tools suitable for temperature control	414
22.4	Cooling-circuit versions	414
22.4.1	Examples of circuits in thermoforming machines	415
22.5	Cooling process	417
22.6	The cooling requirements of a thermoformed part	418
22.6.1	The enthalpy diagram	418
22.6.2	Enthalpy tables	419
22.6.3	Required cooling power for the tool	419
22.7	Design configuration of temperature-control system for a forming tool	420
22.7.1	Material quantity being cooled (material throughput)	421
22.7.2	Required cooling power during production	421

22.7.3	Cooling-water requirement for tool cooling	422
22.7.4	Contact surface required for the cooling water	423
22.7.5	Total length of cooling passages	424
22.7.6	Water velocity	424
22.7.7	Resulting pressure drop in the tool	425
22.7.8	Pressure loss when connecting the forming tool in the machine	427
22.8	Pressure loss in the machine's pipework	429
22.9	Pressure loss in overall temperature-control circuit	430
22.10	Testing the pumping capacity of the connected temperature control or cooling equipment	431
22.11	Assessing the test result	432
22.12	Design configuration options in heat transfer	433
22.13	The effects of air cooling on tool cooling	433
22.14	Preventive maintenance	434
<b>23</b>	<b>Energy consumption in thermoforming</b>	<b>437</b>
23.1	General information	437
23.2	Specific energy consumption in thermoforming	438
23.3	The share of energy costs as a proportion of the manufacturing costs for moldings	441
23.4	Options for reducing the specific energy consumption	444
23.4.1	Saving energy with electric drive units	446
23.4.2	Reduction of energy use in pressure forming	448
23.4.3	Reduction in the volume filled with compressed air, forming air reduction	449
23.4.4	Effects of pressure level	450
23.4.5	Reducing energy consumption during heating	454
23.4.6	Cost reductions with new vacuum pumps	457
23.4.7	Short cooling times reduce energy costs	457
23.4.8	Insulation of pipes?	459
23.4.9	Application of fresh-air coolers instead of refrigeration units with compressor	459
23.4.10	Offset heater starting time reduces price of power	459
23.4.11	Using energy reduction for extended downtime periods	460
23.4.12	Using the machine's basic settings	460
23.4.13	Regular periodic maintenance	460
23.4.14	Dynamic process optimisation	461
23.4.15	The energy consumption display	461
23.4.16	Energy consumption measurements in production	461

<b>24</b>	<b>Thermoforming faults</b> .....	<b>463</b>
24.1	Geometrical configuration errors on the formed part .....	463
24.2	Faults in the material .....	468
24.3	Selection of the correct thermoforming machine .....	470
24.4	Errors during installation of the thermoforming machine .....	471
24.5	Faults in the thermoforming tool .....	471
24.6	Errors during break-in new thermoforming tools .....	473
24.7	Errors during sample article inspections .....	474
24.8	Errors during heating with infrared radiators .....	474
24.9	Pipe and tube cross-sections for air and vacuum .....	475
24.10	Preventing wrinkle formation .....	476
24.11	Fault diagnosis in thermoforming .....	477
	<b>Index</b> .....	<b>489</b>

# 1

## Introduction

Thermoforming is understood as the process of reshaping thermoplastic materials at high temperatures in order to create formed parts.

The illustration in Figure 1.1 shows the concept of a thermoforming process relying on vacuum forming.

The stages in this process are:

- Heating the semi-finished material to its forming temperature within the elastoplastic range
- Endowing it with a shape defined by the thermoforming tool
- Cooling under forced retention, which continues until a temperature at which the formed part achieves geometrical stability is reached
- Demolding the geometrically stabilised formed part

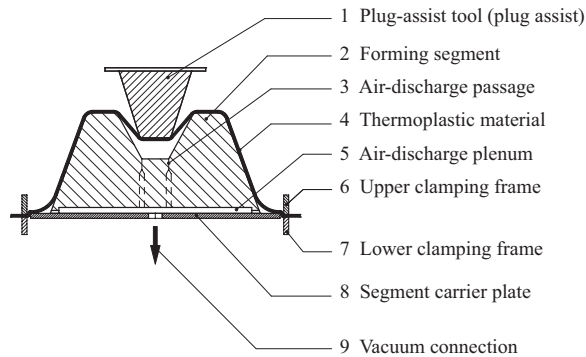
The finished part's wall thickness is defined by the ratio of elongation in the generated surface to the initial surface area. The wall-thickness distribution in the formed part is primarily determined by the mold and the forming procedure.

The contour definition – equating with the accuracy with which the mold's contours are reproduced – is primarily determined by the temperature-sensitive strength of the semi-finished product during the forming process and the effective contact pressure generated between the semi-finished product and the surface of the mold.

The formed part is usually cooled on one side through contact with the mold and on the other side through atmospheric or forced-air cooling.

This process is usually followed by various subsequent treatments, such as cutting, welding, adhesive bonding, hot sealing, painting, metallising and flocking.

The terms “vacuum forming” and “pressure forming” are also employed. This also refers to molding using vacuum and compressed air.



**Figure 1.1** Concept of thermoforming

### Advantages and disadvantages of thermoforming

A manufacturing process will only prove successful provided that it can produce parts of equal quality but at less expense, or in better quality at the same cost. There are also applications in which injection molding and blow molding compete with thermoforming. Thermoforming is usually without competition in the realm of packaging technology, except in those cases in which cardboard and paper are utilised as alternate packaging materials.

The essential benefits of thermoforming are:

- Formed parts with extremely thin walls, such as packaging units, can be manufactured using semi-finished materials with a high melting viscosity, although such parts require granulate with an extremely low melting viscosity for production with injection molding – provided that they can be manufactured at all.
- The smallest thermoformed parts assume sizes on the order of those used for medicinal tablets and button cell batteries. Large formed parts, such as garden ponds, reach sizes extending to between 3 and 6 metres in length. Formed parts in dimensions embracing multiple square metres can be produced without problems, while the process technology imposes no inherent limits on the size of the formed parts or the gauge of the semi-finished material.
- Semi-finished materials with gauges ranging from 0.05 to 15 mm are used, with foamed materials extending to 60 mm.
- Application of multilayer materials renders it possible to produce formed parts with combinations of properties regarding flexural and tearing strength, surface gloss, haptic compliance, anti-slip properties, suitability for sealing, UV resistance, barrier characteristics, embedment of granulate in a layer below the surface, inclusion of layers incorporating fibres, etc. When the individual layers fail to furnish adequate adhesion, then intermediate layers can be incorporated to facilitate bonding.

- Thermoforming is suitable for processing foamed materials, fibre-reinforced materials and thermoplastic materials with laminated textiles as well as preprinted semi-finished products.
- The stretching representing an intrinsic element in the process enhances the formed part's mechanical properties by promoting orientation.
- Owing to forming contact on just one side, thermoforming molds are more economical than (for instance) injection molding tools, which rely on bilateral form contact to define wall thickness.
- The modest tooling costs represent a benefit of using thermoforming for limited production runs. Thermoforming's salient assets in large production runs consist of the minimum wall thicknesses that can be achieved and the high production rates reached by the thermoforming machines.
- Thermoforming machines featuring modular design configurations allow adaptation to the required production rate.
- Waste materials such as the skeletal sheet webs and clamped edge strips are granulated, only to return to the processing cycle when recycled during manufacture of the semi-finished product.

The materials used in thermoforming assume the form of semi-finished products consisting of sheet material in rolls or formed into pre-cut sheets that are produced from granulate or powder in an initial shaping procedure. This entails supplementary expenditures relative to injection molding for the initial material.

In thermoforming, the semi-finished product is only in contact with one side of the thermoforming tool as an intrinsic characteristic of the process. It is for this reason that the formed part represents an accurate reproduction of the mold's contours on only one of its sides. The contour on the opposite side is produced by the resulting elongation.

### **Future perspectives**

Within the plastics-processing sector, it is thermoforming that represents the realm promising the highest growth rates. This applies to formed parts destined for technical applications as well as packaging.

- In its guise as a process that relies on careful craftsmanship and extensive experience, thermoforming is currently in a state of transition as it evolves into a highly controlled process.
- Sensors combine with closed-loop control technology to allow automation of the thermoforming process.
- Recycling waste materials from production, granulation and admixture to form new materials has long been the state-of-the-art in technology.

- Natural “bio” synthetics are becoming progressively more economical. The thermoforming process is predestined to apply these materials for thin-wall packaging with ever-increasing emphasis.
- Application of multilayer materials allows production of parts featuring a wide spectrum of potential applications.
- Meanwhile, in high-wage countries, the trend is continuing toward increased automation, integration of subsequent processes and higher productivity.

# 2

## Basic principles and terminology in thermoforming

### ■ 2.1 Process sequence

The thermoforming process consists of the following individual steps:

1. **Heating** the material to forming temperature
2. **Preforming** the heated material with prestretching
3. **Contour molding** the formed part
4. **Cooling** the formed part
5. **Demolding** the formed part

#### **Heating**

See Chapter 4 “Heating technology in thermoforming”.

#### **Preforming**

Various options for preforming are in existence, i. e.:

- Prestretching with preblow, i. e., bubble formation with compressed air
- Prestretching with presuction, i. e., bubble formation with vacuum
- Mechanical prestretching using a plug assist, also called plug-assist tool or upper plug
- Mechanical prestretching using the form itself
- Combination of the above-cited prestretching options

#### **Contour molding**

Examples of contour molding:

- Contour molding with vacuum (vacuum-forming machines)
- Contour molding with compressed air (pressure-forming machines or vacuum-forming machines with locked molds)



- Contour molding with compressed air and vacuum (pressure-forming machines with supplementary vacuum connection or vacuum-forming machines with locked molds)
- Contour molding with stamping. Stamping allows bilateral definition of the tool's contours. Applied for foamed materials, more rarely for stamping and calibrating edges.

### Cooling

Cooling options for the formed part, based on machine type:

- Cooling through contact with the forming tool (usually unilateral)
- Cooling with air in various versions:
  - Air is ingested from the environment with suction (standard)
  - A building-installed system delivers cool air to the fans
  - Water spray mist is blown into the air current; as this spray mist evaporates in the air stream, it cools the air. At air velocities of approximately 10 m/s and a distance between fan and formed part of roughly 1.5 m, the air cools by about 10 °C. (Notice: When the airspeeds are too high, the formed parts become wet because adequate time for evaporation of the water spray mist is not available.)
- Free cooling in the air if procedure is without mold.

### Demolding

Demolding proceeds once the thermoplastic material has cooled below its pliability temperature, i. e., it is stiff enough.

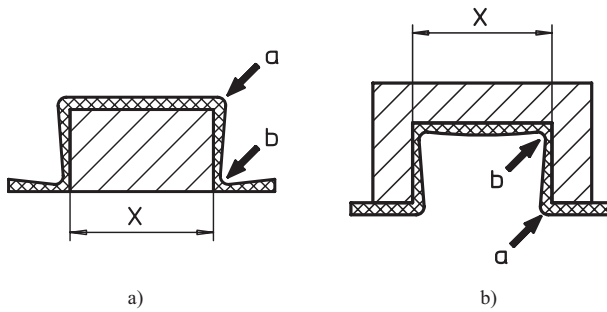
## ■ 2.2 Positive and negative forming

*Positive forming* (Figure 2.1, a):

- Molding reflecting the outer contour of the form (simplified definition)
- The return forces in the material and the contour-molding forces are effective in the same direction.

*Negative forming* (Figure 2.1, b):

- Molding reflecting the inner contour of the form (simplified definition)
- The return forces in the material and the forming forces are mutually opposed.

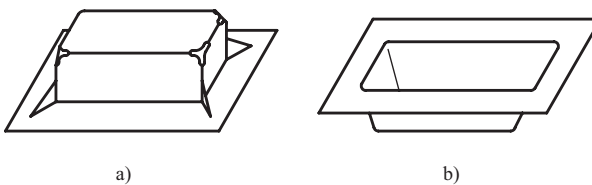


**Figure 2.1** Positive and negative forming  
 a) Positive forming (schematic)  
 b) Negative forming (schematic)  
 X = molded dimension from mold

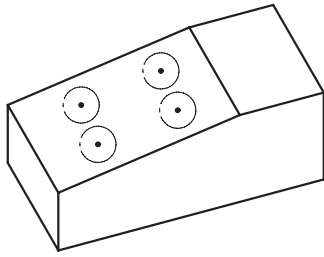
**Table 2.1** Comparison between positively and negatively formed part

Property	Positively formed part	Negatively formed part
<b>Accuracy of molded image in the formed part</b>	On the inside	On the outside
<b>Dimensions (in drawing)</b>	On the inside	On the outside
<b>Thick edge sector</b>	Edge thinned by stretching	Edge remains practically unstretched; wall thickness equals initial thickness
<b>Thickest location*</b>	On base	On edge
<b>Thinnest location*</b>	On edge (transition to sidewall)	On base (transition to sidewall)
<b>Risk of wrinkle formation</b>	At corners contiguous to edge	No wrinkle formation

\* If molded without preforming, with relatively low stretching ratio

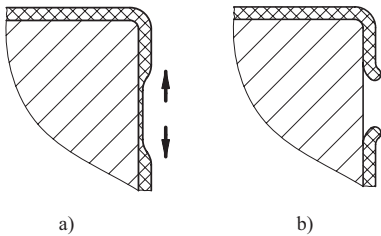


**Figure 2.2** a) Positively formed part with wrinkles toward the edge and chill marks at the corners marking the transitions between base and sidewalls  
 b) Negatively formed part without wrinkles and consistent edge thickness around entire periphery



Circular marks surrounding the air-discharge ports, particularly conspicuous on clear transparent formed parts.

**Figure 2.21** Markings surrounding air-discharge bores on a transparent formed part, schematic



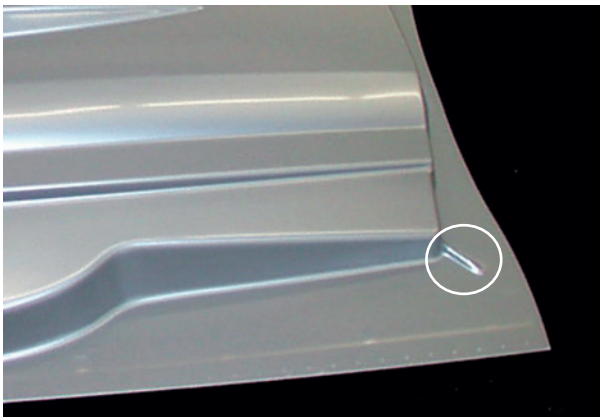
**Figure 2.22**

Separation and open tears

- a) Separation on positive formed part
- a) Open tear on positive formed part

## ■ 2.7 Wrinkle formation during thermoforming

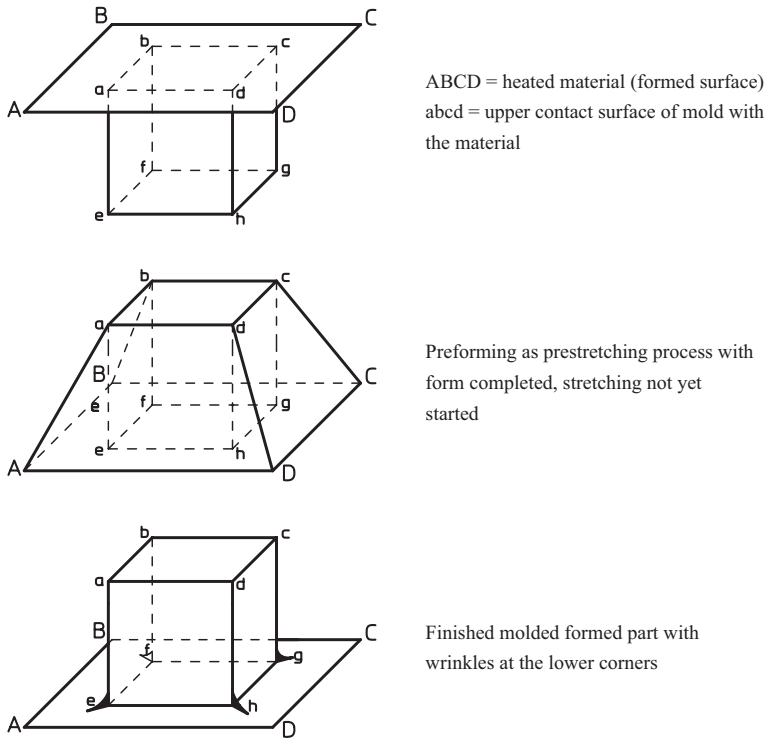
Wrinkle formation is understood as the undesired conjoining of border zones within a heated material during the forming process. Wrinkles can form in both negative and positive formed parts. Examples of wrinkles, see Figure 2.23.



**Figure 2.23** Wrinkle at corner of a positively formed part

### 2.7.1 Wrinkle formation sequence in positive forming

The wrinkle-formation sequence is illustrated in Figure 2.24.

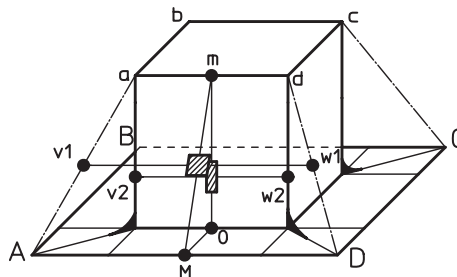


**Figure 2.24** Wrinkle-formation sequence in positive forming

#### Explanation of wrinkle formation in positive forming

Figure 2.25 provides a sketch explaining wrinkle formation.

1. Before the start of contour molding with vacuum or compressed air starts, the hot material is stretched like a tent between the positive form's upper level abcd and the clamped edge ABCD.



**Figure 2.25** Schematic explanation of wrinkle formation on positive form

2. The centre line of the front tent wall AadD is stretched to  $MO + Om$  during contour molding. The element portrayed in the centre stretches upward.
3. The horizontal centre line v1w1 is compressed to the reduced length v2w2 during contour molding.

Conclusion:

- During contour molding, the plastic is elongated in one direction and compressed in the other. (Wrinkles are never produced by stretching, but only through compression.)
- No wrinkles occur as long as the heated plastic remains “compressible” during contour molding.
- This compressibility depends on the visco-elastic properties of the processed material, i. e., on the type of plastic, the plastic temperature, upset ratio and the compression speed.

Wrinkles are produced when the compressibility is exceeded.

The upset ratio is greatest at the lower corner zones of positive forming; thus, the risk of wrinkle formation with rectilinear positive forms is greatest at the corners in the lower zone.

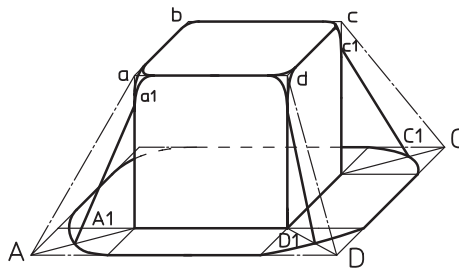
### Preventing wrinkle formation in positive forming

Options for preventing wrinkles:

a) Revising the machine’s adjustment settings:

- Reduce the compression speed by lowering the cross-section for air discharge for a brief period during air suction (“prevacuum”).
- Correct the material temperature to allow compression: Heat the material to a higher temperature if it has been cooling too quickly during stretching.
- Heat the material less if it is formed too quickly during stretching.

b) Prevent wrinkles by reducing the intake zone at the corners. Blinds in the clamping frame reduce the intake zone and, thus, the upset ratio. The principle is illustrated in Figure 2.26. A becomes A1, B becomes B1, C becomes C1 and D becomes D1.



**Figure 2.26** Preventing wrinkle formation in positive forming, schematic

**Table 3.2** Table for the thermoformer (non-binding information) (*continued*)

Thermoplastics	Acronym	Density	Tensile strength	Elasticity modulus	Optical transparency	Linear heat expansion	Specific heat	Continuous-use temperature	
								Min.	Max.
	–	g/cm <sup>3</sup>	N/mm <sup>2</sup>	N/mm <sup>2</sup>	+ Yes – No	10 <sup>-6</sup> °C	kJ/ kg·K	°C	°C
Cellulose acetate	CA	1.28	37	1800	+	110	1.6	-40	80
Cellulose diacetate	CdA	1.27	40	1000	+			-20	60
Cellulose acetate butyrate	CAB	1.18	26	1600	+	120	1.6	-40	60
Polyvinylidene fluoride	PVDF	1.78	43	1500	-	120	0.96	-40	120
Polyetherimide	PEI	1.27	105	2800	-	56			170
PET elastomer	TPE-E	1.17	28	55	-			-50	105
Thermoplastic styrenic elastomer (blends)	TPS blends	1.1–1.39							70–80
Poly lactide acid Polylactic acid	PLA	1.21–1.43	10–60	3500	+		1.3	-20	60–70
Lignin	Lignin	1.3–1.4	25–61	1500–6670	+				85–120

Acronym	Pliability temperature	Crystallite melting range	Predrying of 1.5–2 h/mm panels	Thermoforming temperature		Material factor for heating time	Material factor for cooling time	Venting			
				Pressure forming	Vacuum forming			Vacuum forming		Pressure forming	
								Bore hole	Slot	Bore hole	Slot
–	°C	°C	°C	°C	°C	–	–	mm	mm	mm	mm
PS-GP	80	–	–	120–150	165–190	1.3	0.97	0.8	0.5	0.6	0.3
HIPS	80	–	–	120–160	150–200	1	1	0.8	0.5	0.6	0.3
SBS	90	–	–	115–125	140–140	1	1	0.8	0.4	0.6	0.3
OPS	99	–	–	115	115	1	0.7	0.8	0.6	0.6	0.4
ABS	100	–	75	130–160	160–220	1.3	1.3	0.8	0.5	0.6	0.3
ASA	90	–	85	120–160	160–190	1.3	1.3	0.8	0.5	0.6	0.3
SAN	95	–	–	135–170	165–190	1.6	1.12	0.8	0.5	0.6	0.3
PVC-U	90	–	–	120–140	155–200	1.7	2.55	0.8	0.5	0.6	0.3
COC	2)	–	–					0.6	0.3	0.3	0.2
PE-HD	105	125+15	–	140–170	170–200	2.5	2.5	0.6	0.3	0.4	0.2
PP	140	158+10	–	150–165	160–200	2.1	2.1	0.6	0.3	0.3	0.2
PMMA, ext.	95	–	70	140–160	160–190	1.5	1.5	0.8	0.6	0.8	0.5
PMMA, molded	100	–	–	140–170	170–200	1.6	1.6	1.0	0.8	0.6	0.3
POM	120	165+10	–	145–170	170–180	3.7	1.85	0.6	0.4	0.4	0.2
PC	150	–	100	150–180	180–220	1.5	0.9	0.6	0.5	0.6	0.3
PAR	170	–	110	180–210	210–235	2.6	2.21	0.8	0.5	0.6	0.3
PPE (PPO)	120	–	–	180–230	200–250	1.8	1.44	0.8	0.5	0.6	0.3
PA 6 GF15Z		222	110	230–240	240–250			0.8	0.5	0.6	0.3

**Table 3.2** Table for the thermoformer (non-binding information) (continued)

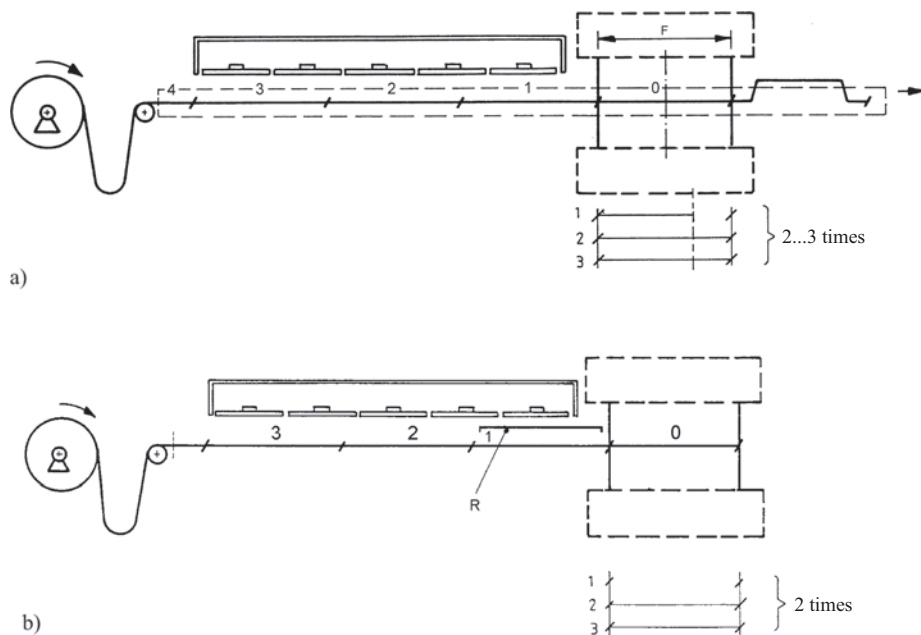
Acronym	Pliability temperature	Crystallite melting range	Predrying of 1.5–2 h/mm panels	Thermoforming temperature		Material factor for heating time	Material factor for cooling time	Venting			
				Pressure forming	Vacuum forming			Vacuum forming		Pressure forming	
								Bore hole	Slot	Bore hole	Slot
–	°C	°C	°C	°C	°C	–	–	mm	mm	mm	mm
PA 12	150	175+10	80	160–180	170–180	2.5	2	0.8	0.5	0.6	0.3
PET–G	82	–	–	100–120	110–190	1.25	0.88	0.8	0.4	0.6	0.3
A-PET	86	–	65	100–120	110–120	1.25	0.88	0.8	0.4	0.6	0.3
C-PET	86	225+3	–	130–145	/	/	/	/	/	0.6	0.4
PSU	178	–	120	210–230	220–250	2.9	2.32	0.8	0.5	0.6	0.3
PES	220	–	180	230–270	265–290	–	–	0.8	0.6	0.6	0.3
PPS	260	280+8	–	260–270	260–275	3.5	0.87	0.6	0.3	0.4	0.2
A/MA/B	88	–	–	135–150	160–220	1.3	1.69	0.8	0.4	0.6	0.3
CA	98	–	65	145–170	165–180	1.5	1.5	0.8	0.5	0.6	0.3
CdA	70	–	60	115–130	120–140	–	–	0.8	0.4	0.6	0.3
CAB	120	–	90	140–200	170–200	1.5	1.5	0.8	0.5	0.4	0.2
PVDF	150	170+8	–	170–200	170–240	3	3	0.8	0.5	0.6	0.3
PEI	215	–	150 <sup>1)</sup>	230–290	240–330	2.7	0.62	0.8	0.5	0.6	0.3
TPE-E	108	–	–	–	135–143	1.5	1.5	0.6	0.5	/	/
TPS				120–140	140–165	1	1	1	0.4	0.6	0.3
PLA	58	–	–	80–100	90–110	0.9	0.8	0.8	0.4	0.6	0.3
Lignin				150–170	170–190	1	1.3	0.8	0.4	0.6	0.3

<sup>1)</sup> Drying time 4 h/mm<sup>2)</sup> Depending on type, 70 ... 160 °C

Acronym	Optimum temperature for the mold					Material for plug-assist tool					Molding shrinkage
						1 Wood 2 Felt 3 POM 4 PA (PA 6GGK) 5 Syntact. Foam ...			6 Talcum-filled PU 7 Pertinax 8 Hy-tacB1X 9 PTFE		
	UA SB	RV(b) RD	RDKP RDK	RDM	HSA FS	UA SB	RV(b) RD	RDKP RDK	RDM	HSA FS	
–	°C	°C	°C	°C	–	–	–	–	–	–	
PS-GP	80	/	15	15	/	1, 2, 6, 7	/	2, 5	2, 5	/	0.5
HIPS	70	25	20	15	–/15	1, 2, 6, 7	1, 2, 5, 6	2, 5	2, 5	2, 5	0.5
SBS	50	25	20	15	40/20	1, 2, 3, 6, 7	1, 3, 5	3, 5	3, 5	3, 5	0.5
OPS	65	/	65	40	/	2, 5	/	2, 5	2, 5	/	0.5
ABS	85	35	20	15	–/15	1, 2, 4, 6, 7	1, 2, 4, 5	2, 5	2, 5	2, 5	0.6–0.7
ASA	85	–	20	15	–	1, 2, 4, 6, 7	–	2, 5	2, 5	–	0.3–0.7
SAN	85	–	–	–	–	1, 2, 4, 6, 7	–	–	–	–	0.4–0.7
PVC-U	25	25	20	15	35/15	1, 2, 6, 7	1, 2, 5, 7	2, 5	2, 5	2, 5	0.4–0.5
COC	–	–	–	–	35/15					3, 4, 5	
PE-HD	100	50	35	20	–	1, 4, 6, 7	1, 4, 5, 7	4, 5	4, 5	–	1.2–5.0
PP	90	(25)	25	15	–/15	1, 3, 4, 6, 7	3, 4, 5, 7	3, 4, 5	3, 4, 5	3, 4, 5	1.5–1.9

### Effect of transport steps under a long heater

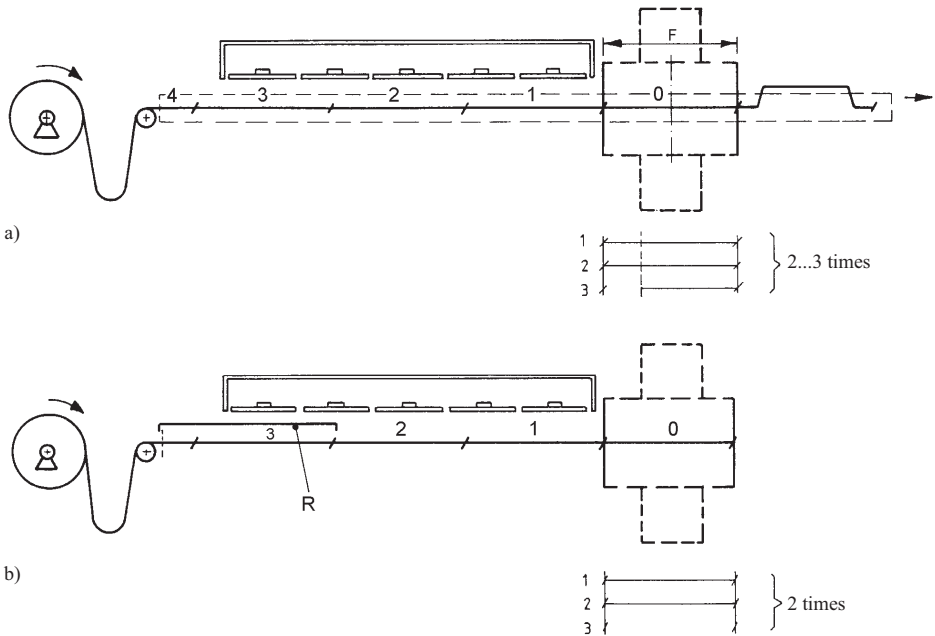
Every point on the surface of the semi-finished product must have a single temperature in the forming station. To obtain this result, it is necessary to ensure that each point in the advance-feed direction is heated with the same frequency as all others. If this is not the case, it remains possible to shield the surface from the radiant heat or to deactivate transverse heater element rows (Figure 4.14 and Figure 4.15).



**Figure 4.14** Checking the heating through a whole number of advance-feed cycles (2 or 3 times)  
 Case: Machine tables widths wider than the mold  
 0, 1, 2, 3, 4 steps (countdown) in transporting  
 F: Forming surface (advance feed)

If the machine's table width is wider than that of the mold, then there will be differences in how the blank is heated before it arrives in the forming station (Figure 4.14 a). If the sector of the heater in front of the forming station is covered, then all points on the blank will be heated exactly two times (Figure 4.14 b).





**Figure 4.15** Checking the heating with a whole number of advance-feed cycles (2 or 3 times)  
 Case: Machine table widths narrower than the mold  
 0, 1, 2, 3, 4 steps (countdown) in transporting  
 F: Forming surface (advance feed)

If the machine's table width is narrower than that of the mold, then there will be differences in how the blank is heated before it arrives in the forming station (Figure 4.15 a). If the sector of the heater in front of the forming station is covered, then all points on the blank will be heated exactly two times (Figure 4.15 b).

The schematic explanation in Figure 4.14 and Figure 4.15 only applies to the upper heater deflection panel. In actual real-world application, there will also be a lower heater deflection panel. The procedure for heating with an upper heater and lower heater is similar, even if two heater deflection panels are not of equal length or are not perfectly aligned above each other in the advance-feed direction.

### Cross-over effect with radiant heaters

When a heater panel travels from its standby position to its heating position at the start of each cycle and then returns to its standby position once the heating time has elapsed, this leads to the cross-over effect, meaning that the semi-finished product is heated for different amounts of time because the heater crosses over it. More rapid heater travel motion corresponds to reduced cross-over effect and vice versa.

# 8

## Thermoforming process on sheet-processing machines

The thermoforming process can be subdivided into two steps – preforming or pre-stretching/drawing, and the actual contour-molding process. In many cases, unassisted contour molding with vacuum or compressed air will not be able to achieve satisfactory wall-thickness distribution, and for this reason, preforming will be necessary. The objective behind preforming is to obtain a contour that comes as close as possible to the contour of the finished part. The molding's final contour definition is produced during finish molding. In most cases, preforming has a greater influence on wall-thickness distribution than contour molding.

Preforming is always a prestretching process and can assume various forms:

- Mechanical prestretching with the actual mold
- Mechanical prestretching with a plug assist (prestretcher)
- Pneumatic prestretching with preblow or presuction
- Combination of mechanical and pneumatic prestretching

Depending on the machine's equipment and the configuration of the forming tool, molding relies on:

- Vacuum (vacuum forming)
- Compressed air (compressed-air forming)
- Vacuum and compressed air
- Bilateral vacuum application (e. g., for foams)
- Supplementary stamping, crimping, calibrating, usually restricted to limited surface areas

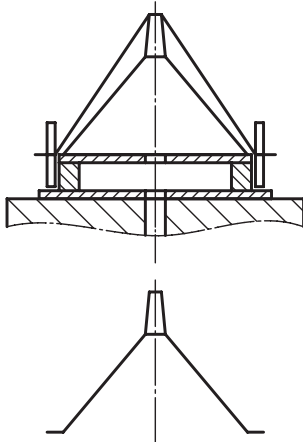
Mechanical tools such as slides and plugs usually are intended to prevent wrinkles during molding. In some cases, forming relies on mechanical stretching only, without molding using vacuum or compressed air. This is the origin of what we call free-form surfaces.

The forming processes cited below will all be explained in the following combination:

- Sketch of forming process
- The essential steps in the process sequence
- Important instructions/to be observed
- Possible intervention by the machine's operator with the resulting effect on the molding
- Required machine equipment

## ■ 8.1 Positive forming

### 8.1.1 Positive forming with mechanical prestretching



Preforming:

- Prestretching with the mold
- With or without preblow

Contour molding:

- With upper forming table vacuum on

**Figure 8.1** Process sequence – without preblow, without upper table

#### Please note

- Wall-thickness distribution in the vicinity of the tip

**Table 8.1** Positive forming

Operator intervention	Effect on the molding
<ul style="list-style-type: none"> <li>■ Bubble height = 0 ... low</li> <li>■ Bubble height corresponds to 2/3 of forming height</li> <li>■ Bubble height corresponds to forming height</li> </ul>	<ul style="list-style-type: none"> <li>■ Tip thick</li> <li>■ OK</li> <li>■ Wrinkle formation risk on the surface</li> </ul>
<ul style="list-style-type: none"> <li>■ Cold mold</li> <li>■ Hot mold</li> </ul>	<ul style="list-style-type: none"> <li>■ Tip thicker</li> <li>■ Tip thinner</li> </ul>
<ul style="list-style-type: none"> <li>■ Low table speed</li> <li>■ High table speed</li> </ul>	<ul style="list-style-type: none"> <li>■ Tip thicker</li> <li>■ Tip thinner</li> </ul>
<ul style="list-style-type: none"> <li>■ Cold mold and low table speed, without preblow</li> <li>■ Hot mold and high table speed with preblow</li> </ul>	<ul style="list-style-type: none"> <li>■ Thickest tip</li> <li>■ Thinnest tip</li> </ul>

#### Required machine equipment

This forming procedure can be performed on all thermoforming machines with basic equipment.



**Figure 17.3** Left: 5-axis milling machine (illustration provided by MAKA)  
Right: Milling spindle

## ■ 17.2 Deburring

No deburring is necessary following punching with the steel rule die, punch and die trimming tool, shear cutting or laser cutting. Deburring is performed in response to a coarse cut:

- After sawing with a cut-off saw
- After milling in some cases
- after abrasive jet machining in many cases

Deburring is carried out by hand with a deburring cutter, with electric deburring brushes, or in a fully automated process (i. e., on multi-axis machines).

## ■ 17.3 Connecting

### **Welding**

Various welding processes are available for use with thermoplastic materials:

- Friction welding
- Ultrasonic welding
- Vibration welding (angular motion friction welding)

- Hot-tool welding (butt welding with heat reflectors)
- Hot-gas welding
- High-frequency welding
- Induction welding

The following welding technologies are applied with thermoformed parts:

- Ultrasonic technology
- Vibration technology
- HF (high-frequency) technology
- Hot-tool welding

Not all plastics are suitable for ultrasonic and high-frequency welding.

### **Adhesive bonding**

Suitable, standard commercial adhesives are available for bonding. The surfaces being bonded must be clean and grease-free and should also be roughened. Plastics with “adhesive-resistant” surfaces, such as PE, PP, POM, require extensive surface pretreatments (flame treatment, electric surface discharges or chemical pretreatments). Information regarding selection of adhesives, see Chapter 3 “Semi-finished thermoplastic materials”, with the plastics discussed at this location. An adhesive manufacturer should be consulted as the need arises.

### **Riveting, threaded connections**

Since the strength of plastics is not as high as that of metals, the employed diameters and pressure surfaces should be correspondingly larger, in a situation mirroring that encountered with wood.

Special plastic screws are available for connecting plastics.

### **Reinforcement**

The rigidity of a formed part depends on:

- The employed plastic (Young’s modulus)
- The wall thickness produced during thermoforming
- The geometry of the formed part (length, width, height, radii, ribs, etc.)
- The application temperature

Reinforcement is logical if:

- a) the rigidity obtained during thermoforming is not adequate,
- b) subsequent reinforcement is more economical than application of thicker or more expensive initial material,
- c) no reinforcement is supplied by a subsequent process, such as insulation, adhesive bonding, welding.

Various reinforcement options are available:

- Lamination with fibreglass
- Foam backing with integral or PU foam
- Bonding reinforcement elements
- Applying poured material (e.g., in thin corners with epoxy resin)

### **Surface treatment**

The options for treating surfaces of formed parts are:

- Grinding, polishing
- Painting
- Embossing
- Metallising
- Galvanising
- Flocking
- Antistatic treatment (antistatic spray, antistatic bath, rinse with detergent solution)

## **■ 17.4 Recycling**

Direct on-site recycling of materials represents the current state of technology. Edge trim cuts during production of sheet material and presorted waste are returned for remelting and sheet extrusion following post-production granulation. Problems can arise when contamination is present if different types of plastic are mixed or when waste materials have different colours.

Mixed plastic waste, including that from recycling centres, can be processed with extrusion or pressing to produce parts for less demanding applications, primarily for garden and landscaping, but also for industry and commercial uses.

Most suppliers of sheet material on reels or in sheet panels accept returned plastic waste. In any case, it is essential to negotiate with the supplier regarding acceptance of returned waste material when requesting information on materials and placing orders. Waste materials, possibly in granulated form, are secondary raw materials and are utilised.

## ■ 18.4 Factors affecting the punching process

### Influences on the plastic being punched

Property	Effect on ...
Plastic type	<ul style="list-style-type: none"> <li>▪ Specific punching force, see Section 18.7 “Punching forces”</li> <li>▪ Service life of die tool</li> <li>▪ Abrasive bulking agents in the sheet material and abrasive print colours on the sheet material reduce the residence time</li> <li>▪ Angel-hair formation</li> </ul>

### Influences on the formed part being punched and the design of the formed surface

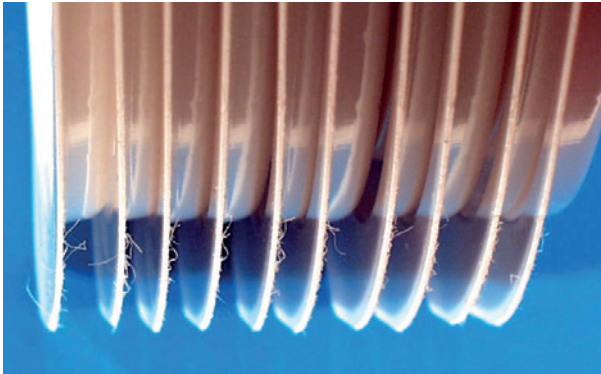
Property	Effect on ...
Material thickness on the punched part	Punching force
Total cut length	Punching force Other factors requiring consideration: <ul style="list-style-type: none"> <li>▪ Number and size of radii per m: Small radii increase the displacement forces and thus the required punching force.</li> <li>▪ Proportion of cut length with narrow parallel cut lines (below 12 mm) of total cut length increases punching force</li> </ul>
Punched edge tolerance	Selection of punching procedure
Cut quality (haptics)	Selection of punching procedure

### Effects of the machine/Punching station

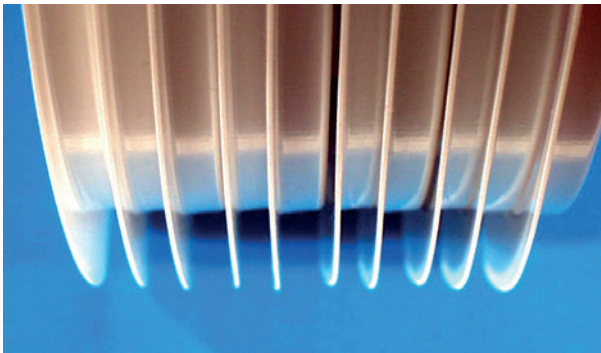
Property	Effect on ...
Punching force	Punched length/Design of formed surface/Machine output
Punched surface	Punched length/Design of formed surface/Machine output
Punching station rigidity	With blade cut in separate punching station: Effect of the residence time of the cut line
Punching speed (cutting speed)	Effect of the heated punch line when the blade edge cuts more slowly
Blade cut adjustment mechanism (position of transverse and angular position of the die tool relative to the direction of production flow)	Punched edge accuracy Adaptive possibility with distortion (deformation) in the formed sheet-material strip

## ■ 18.5 Angel-hair formation

Figure 18.22 shows punched edges with and without punched material strands (angel hair).



Punching threads at edge = "angel hair"



Edge without punching threads

**Figure 18.22** Punched edge of a container in HIPS, edge thickness 0.6 mm



### 22.7.1 Material quantity being cooled (material throughput)

$$m = L \cdot B \cdot s_1 \cdot \rho_m \cdot \frac{3600}{T_z} \cdot 10^{-6} \quad (22.1)$$

$m$  = Material throughput per hour in kg/h.

$L$  = Length (advance feed length or panel length), in mm (Important: Only the length being cooled, without the uncooled clamped edges)

$B$  = Width (e. g., roll-fed sheet-material width or panel width), in mm (Important: Only the width being cooled, without the uncooled clamped edges)

$s_1$  = Exit thickness of the semi-finished material (sheet material or panel), in mm

$\rho_m$  = Density of the semi-finished material (sheet material or panel), in g/cm<sup>3</sup>

$T_z$  = Cycle time, conversion of cycles per minute to cycle time in s.:

$$T_z = \frac{60}{\text{cycles per minute}}$$

#### Example:

$L = 1200$  mm

$B = 800$  mm

$s_1 = 5$  mm

$\rho_m = 1.05$  g/cm<sup>3</sup>

$T_z = 65$  s

$$m = 1200 \cdot 800 \cdot 5 \cdot 1.05 \cdot \frac{3600}{65} \cdot 10^{-6} = 279.14 \text{ kg/h} \quad (22.2)$$

### 22.7.2 Required cooling power during production

$$Q = m \cdot \Delta H \cdot k \cdot S \quad (22.3)$$

$Q$  = Cooling power, in kJ/h

$m$  = Material throughput per hour in kg/h

$\Delta H$  = Enthalpy difference during the cooling period, in kJ/kg  
See graphic in Figure 22.3 or the values in tabular form

$k$  = Factor for proportional cooling through contact with the forming tool (without air cooling)

- For machines without air cooling (RDM, RDKP, etc.)  $k = 1$
- For machines with air cooling (UA)  $k = 0.5 \dots 0.7$

$S$  = Factor reflecting heat loss

- for tool temperature of 15 ... 50 °C,  $S = 0.1 \dots 0.95$
- for tool temperature of 50 ... 100 °C,  $S = 0.95 \dots 0.85$
- for tool temperature of 100 ... 140 °C,  $S = 0.85 \dots 0.75$

When a tool is extremely hot, it will lose a portion of its heat to the environment. Accordingly, less cooling power must be conducted to the tool in the cooling water.

**Example (continued):**

$$m = 279.14 \text{ kg/h}$$

$$\Delta H = 198 \text{ kJ/kg}$$

$$k = 0.6$$

$$S = 0.9$$

$$\begin{aligned} Q &= m \cdot \Delta H \cdot k \cdot S \\ &= 29.845 \text{ kJ/h} = 8.3 \text{ kW} \end{aligned} \quad (22.4)$$

It is now possible to examine the cooling power of an available cooling device using the calculated cooling power. This value can also be employed to evaluate the heat exchanger if the heat from the forming tool is not directly discharged with the cooling water, but instead with the heat exchanger of a temperature-control unit. This is indicated under “cooling power” for temperature-control units with heat exchangers. If the total heat is discharged through two or more temperature-control units, then this fact must also enter consideration.

### 22.7.3 Cooling-water requirement for tool cooling

The required cooling water can be calculated with the following formula:

$$V = \frac{1}{60 \cdot \Delta T_M} \cdot \frac{Q}{c_M \cdot \rho_M} \quad (22.5)$$

For water:

$$V = \frac{1}{250.8} \cdot \frac{Q}{\Delta T_M} \quad (22.6)$$

$V$  = Total volumetric flow rate for cooling water, in litres/min.

$Q$  = Cooling power, in kJ/h

$\Delta T_M$  = Difference in entry and exit temperatures of cooling medium (water), in °C

▪ For forming and punching tools (RDM)  $\Delta T_M = 1$  to  $2$  °C

▪ For other forming tools (UA, RV, RDKP, etc.)  $\Delta T_M = 3$  to  $10$  °C

$c_M$  = Specific heat of heat-transfer medium, in kJ/kg K

▪ For water,  $c_M = 4.18$  kJ/kg K

$\rho_M$  = Density of cooling medium in g/cm<sup>3</sup>

▪ For water,  $\rho_M = 1$  g/cm<sup>3</sup>

**Example (continued):**

$$Q = 29,845 \text{ kJ/h}$$

$$\Delta T_M = 7.5 \text{ }^\circ\text{C}$$

$$V = \frac{1}{250.8} \cdot \frac{Q}{\Delta T_M} \quad (22.7)$$

$$= 15.9 \text{ litres / min}$$

**22.7.4 Contact surface required for the cooling water**

The cooling water's contact surface can be calculated with the following formula. The calculations apply only for clean cooling passages without deposits.

$$A = \frac{Q}{3600 \cdot \alpha} \cdot \frac{1}{\Delta T_{MF}} \quad (22.8)$$

$A$  = Contact surface of cooling water, in  $\text{m}^2$

$Q$  = Cooling power, in  $\text{kJ/h}$

$\alpha$  = Heat transfer coefficient, in  $\text{kW/m}^2 \text{ }^\circ\text{K}$

▪ For water,  $\alpha = 2.3$  to  $3.5 \text{ kW/m}^2 \text{ }^\circ\text{K}$

$\Delta T_{MF}$  = Temperature differential between tool surface and heat-transfer medium ( $^\circ\text{C}$ )

The temperature differential varies according to the tool material, the distance between the tool's surface and the cooling passage, and the ratio of cooling time to cycling time. The recommended temperature differentials for thermoforming tools lie between 8 and 15  $^\circ\text{K}$  with sheet-processing machines and between 12 and 25  $^\circ\text{K}$  with automatic roll-fed machines

This can be used to calculate the product for round passages of  $d \cdot l$ :

$$(d \cdot l_{\text{total}}) = \frac{Q}{3.6 \cdot \pi \cdot \alpha} \cdot \frac{1}{\Delta T_{MF}} \quad (22.9)$$

$(d \cdot l_{\text{total}})$  = auxiliary parameter, in  $\text{mm} \cdot \text{m}$ ; here, the definitions are  $d$  for the cooling passage diameter in  $\text{mm}$  and  $l_{\text{total}}$  for the total length of the cooling passage

$Q$  = Cooling power, in  $\text{kJ/h}$

$\alpha$  = Heat transfer coefficient, in  $\text{kW/m}^2 \text{ }^\circ\text{K}$

▪ For water,  $\alpha = 2.3$  to  $3.5 \text{ kW/m}^2 \text{ }^\circ\text{K}$

$\Delta T_{MF}$  = Temperature differential between tool surface and heat-transfer medium ( $^\circ\text{C}$ )





# Index

3K method 190  
6-position switching 164

## A

ABS 75  
Absorption of IR radiation 128  
AB stacking 271  
Adhesive bonding 277  
Adhesive lamination 198  
Adjustable mold substructure 357  
Adjustable substructures 357  
Aftershrinkage 45  
Air consumption 453  
Air cooling 253  
Air-discharge cross-sections 364  
Air-discharge passage 365  
Air-discharge passage system 365  
Air draught 142  
Air-permeable panel material 342  
Air support 56  
Air support during heating 383  
AIOx 119  
Alternating stacking 272  
Aluminium-ceramic investment casting 341  
Aluminium tools 340  
Aluminium with resin front cast coating 341  
Amorphous 35  
Angel hair 297  
Anisotropic contraction 333  
Arithmetical average surface roughness Ra 361

ASA 76  
Assessing suitability for stacking 265  
Averaged roughness depth Rz 361

## B

Backing 340  
Banded 325  
Barrier 116  
Barrier properties 118  
Basic settings 460  
Biodegradable plastics 110  
Bio-PE 116  
Bio-PET 115  
Bioplastics 109  
Bio-PP 116  
Blade cut 279–280  
Blade-cut tools 282  
Blister contours 466  
Blocking properties 105  
Blow pins 384  
Brand names 126  
Breaking in 473  
Bubbles 37, 232

## C

CA 115  
Calculating wall thickness 33  
Calenders 64  
Camper window 239  
Cardboard-plastic composite 324  
Casting semi-finished products 65  
Causes of distortion 334

- Cavities 368
  - Central cooling air 254
  - Centre-alignment edge 270
  - Changing the contour of the plug-assist tool 372
  - Checking for homogeneous heating 139
  - Check water quality 409
  - Chill marks 13, 258
  - Clamped edge distortion 333
  - Clamshell packages 21
  - Claw-type vacuum pump 457
  - Clearances for negative forming segment 346
  - Clearances for positive forming segments 345
  - Clearances to the clamping frame 345
  - Cockpit windows 241
  - Coefficient of thermal linear expansion 39
  - Compact technology 396
  - Comparison of heater elements 143
  - Comparison of radiant heaters 142
  - Compensation 39
  - Compensation during heating 149
  - Composite semi-finished materials 116
  - Configurable fans 254
  - Contact heater plate 152
  - Contact heaters 151
  - Continuous fibres 122
  - Continuous-use temperature 55
  - Contour definition 44, 58
  - Contour molding 5
  - Contour-molding pressure 11
  - Contours for package hinges 386
  - Contour shields 346
  - Control zone 159
  - Convection heaters 153
  - Conversion Rz to Ra 361
  - Cooler molds 260
  - Cooling 6, 62, 251
  - Cooling devices 251
  - Cooling power with air 255
  - Cooling with ice water 253
  - Copper-beryllium alloys 342
  - Corner blow nozzles 185
  - Corner wrinkles 374
  - Corrosion prevention 408
  - Cover shield 398
  - Cover tool 393
  - CPET 100
  - Crease geometry 387
  - Creasing 387
  - Creasing force 388
  - Creasing force determination 389
  - Cross-over effect 140
  - Cup rim geometries 397
  - Cup rims 397
  - Cut location 398
  - Cutting boards 281
  - Cutting forces for blade-cut tools 306
  - Cutting geometries 280
  - Cutting play 398
  - Cutting punch 398
- D**
- Damage 41
  - Deactivated heater 131
  - Deactivated heater element 134
  - Deburring 276
  - Decoration 315
  - Delivery of central cooling air 256
  - Demolding motion 263
  - Demolding process 261
  - Demolding temperature 251, 261
  - Demolding undercuts 262
  - Depolymerisation 155
  - Detachable parts 375
  - Determining distortion-printing image 249
  - Determining the contour of the plug-assist tool 371
  - Determining the size of the material 349
  - Die drool 304
  - Digital printing 326
  - Direction of extrusion 53
  - Direction of orientation 59
  - Distance between heater elements 132
  - Distortion 258, 329
  - Distortion printing 246, 322

Distribution of energy consumption 442  
 Double cut 301  
 Downholder 401  
 Downholder activation 401  
 Downholder control 219  
 Downholder pressure stages 220, 402  
 Downholders 30  
 Downtime periods 460  
 Draft angles 32  
 Drill holes 364  
 Dry offset 327  
 Dynamic process optimisation 461

## E

Effective heating time 154  
 Electrical conductivity 409  
 Emissions factor of the surface of a heater element 134  
 Emissions level 129  
 Energy consumption 437  
 Energy consumption display 461  
 Energy consumption measurements 451, 461  
 Energy costs 441  
 Energy recovery 447  
 EPE 108  
 EPET 100  
 EPP 108  
 Evenly heated 136  
 EVOH 84, 119  
 Expansion 39  
 Extrusion 64

## F

Fabric 122  
 Fastening knob versions 390  
 Fault diagnosis 477  
 Faults in the material 468  
 Faults in the thermoforming tool 471  
 Felt 117, 369  
 Fibre-reinforced 121  
 Filled 82  
 Finish-processing 273

Flocked 321, 327  
 Flow chart 218, 220  
 Foamed material 85  
 Format printing 243  
 Forming-air reduction 219, 407, 449  
 Forming and punching tool with blade cut 285  
 Forming and punching tool with shear cut 291  
 Forming pressure 8, 10  
 Forming ratio 31, 61  
 Forming surface 29  
 Forming temperature range 41  
 Forming temperature ranges 89  
 Forming transparent parts 229  
 Free blowing 236  
 Free shrinkage 51  
 Free suction 236  
 Fresh-air coolers 459  
 Friction properties 42  
 Full-surface printing 320

## G

Galvanized 328  
 Geometrical configuration errors 463  
 Grained 320  
 Grid 61  
 Guillotine shearing table 312

## H

Halogen heater 142  
 Heat deflection for clamping frames 455  
 Heated wooden molds 241  
 Heater element's distance 132  
 Heater element size 134  
 Heat expansion 87  
 Heating 37  
 Heating multicoloured materials 173  
 Heating techniques 127  
 Heating technology 127  
 Heating with isothermal control 158  
 Heat transfer 127



Height transitions 467  
 Helicopter windows 241  
 High-gloss coating 117  
 Hinge production 389  
 HIPS 72  
 Hole punch 314  
 Hollow base 227  
 Hollow ceramic element 142  
 Horizontal cut-off saw 273  
 Hydrographic 328  
 Hygroscopic 36

**I**

ILLIG RDKP machine 356  
 ILLIG RV machine 354, 355  
 ILLIG SB machine 353, 354  
 ILLIG UA machine 355  
 IML 223  
 IML-T 324  
 Influencing wall thickness distribution 209  
 Infrared radiation 127  
 Infrared sensor 167  
 In-line thermoforming 92  
 Insert technology 395  
 Intake zone 466  
 Internal stresses 56  
 Interrupted welded seam 383  
 IR sensor 168  
 IR sensor with power-controlled heaters 168  
 Isotherms 159

**J**

Joint zone 468  
 Joystick distribution of the heating pattern 162

**K**

Knife cut 391, 394  
 Knit fabric 122

**L**

Labelling 223  
 Laminated 323  
 Laminated wood 369  
 Lamination options in edge zones 200  
 Lamination process 199  
 Lateral stretching ratio 464  
 Lignin 114  
 Long fibres 122  
 Longitudinal row control 170

**M**

Machine capability 124  
 Machining allowances 466  
 Markings 23  
 Material displacement during punching 307  
 Materials for plug-assist tools 368  
 Materials for the forming segment 338  
 Metallised 321  
 Metallising 119  
 Metal spray coating 340  
 Migration 120  
 Minimum heating time 154  
 Modified 83  
 Moisture 36  
 Moisture bubbles 36  
 Mold and countermold 228, 236  
 Molding shrinkage 45, 58  
 Mold insert 399  
 Mold temperature 257  
 Multilayer 85, 116  
 Multilayer semi-finished materials 117  
 Multi-positional control 160, 164

**N**

Nickel electroplating 342  
 Non-degradable 115

**O**

Offset heater starting time 459

Offset stacking lugs 271  
 OPS 74  
 Orientation 53, 59, 64

## P

PA 99  
 Painted 327  
 Pallet 465  
 PAN 120  
 PBS 113  
 PC 98  
 PE 79  
 Permeability 118  
 Permeation 118  
 PET 100, 101  
 PET-A 100  
 PET-C 100  
 PET-G 100  
 PETG 100  
 PHA 111  
 pH value 409  
 Pilot heater element 142  
 Pipe and tube cross-sections 475  
 PLA 110  
 Plenum passage 365  
 Plug-assist tool 404  
 Plug-assist tool materials 405  
 PMMA 95–96  
 Polyurethane resin 369  
 POM 370  
 Positive and negative forming 7, 178  
 Positive or negative forming 343  
 Potentially achievable forming ratios 464  
 Power control 150, 160  
 Power output of heaters 128  
 Power reduction 161  
 PP 80  
 Preblow 12  
 Preforming 5, 177  
 Preheating for automatic roll-fed machines 456  
 Preprinted 321, 323  
 Pressure amplifier 403

Pressure equalisation 12, 261  
 Prestretching 177  
 Presuction 12  
 Presuction and unreeling 183  
 Preventing wrinkle formation 476  
 Primer 119  
 Print image versions 243  
 Printing ink 243  
 Process for lamination with collapsing stroke 201  
 Processing shrinkage 260, 348  
 Pronounced potential influence on wall-thickness distribution 212  
 PR/SEC 439  
 PS 71  
 PSU 107  
 PTFE 370  
 Punching 279  
 Punching stroke 398  
 Push button negative section 21  
 Push button positive section 21  
 PVC 78  
 PVDC 84, 119

## Q

Quartz heater 142

## R

Ra 361  
 Radiant heaters 127  
 Radiated heat output 129  
 Radii 363  
 Raising the forming segment 377  
 RDM forming station 215  
 RDM tool 394  
 Recommendations for roughnesses 362  
 Recommended venting holes 366  
 Recovery properties 55  
 Rectilinear interlacing of fabric 122  
 Recycling 278  
 Recycling material 117  
 Reducing chill marks 19

- Reducing energy consumption 444–446, 454
- Refinement processes 65
- Reflection 136
- Reflective surfaces 138
- Reflectors 136
- Reinforced 83
- Reinforcement 277
- Releasing the formed part 262
- Relocating the welding plane 381
- Reproducibility of heating results 145
- Required cross-section 366
- Residence time 154–155
- Resin 369
- Resin front cast coating 340, 341
- Resin tools 339
- Ribs and 468
- Rimless formed parts 226
- Rotary die cutting machine 274
- Roughness 362
- Roughnesses from processing 362
- Rough trim cut 275
- Rules of thumb for demolding 263
- Rz 361
  
- S**
- Sag 39, 54
- Sample article inspections 474
- SAN 77
- SBS 73
- Scattered printing 243, 322
- Scrap zone 466
- Sealing locations on substructures 358
- Sealing wall 401
- SEC value 438
- Selecting the correct forming procedure 208
- Self-adhesive labels 325
- Semi-crystalline 35
- Semi-finished products in multiple layers 65
- Separation and open tears 23
- Serrated knife 384
- Shear cut 286
- Sheet extrusion 84
- Sheet-material hinge 385
- Short cooling period 458
- Short fibres 121
- Shrink label 326
- Side clearance in the stack 266
- Sidewall draft 345, 359
- Sidewall inclination angles 266
- Silkscreen printing 326
- SiO<sub>x</sub> 119
- Skeleton tool 237
- Sleeve 326
- Slider 375
- Slots 364
- Slotted nozzles 364
- Snap buttons 390
- Snap coupling 385, 389
- Specific energy consumption 438
- Stacking interval 266
- Stacking method 272
- Stacking undercut 268, 269
- Stack length 267
- Stamped 323
- Stamping 177
- Steel rule cutting lines 282
- Steel rule die cut 391, 394
- Steel tools 342
- Strength 59
- Stresses 40, 55
- Stretch 61
- Stretching 65
- Stretching ratio in lateral negative sectors 464
- Stretch in printed pattern 345
- Substructure 351
- Superimposed position in percent 166
- Superimposed power control 160
- Surface roughness 360
- Surface structures 322
- Surface treatment 278
- Surface wrinkles 27
- Suspension hole for packaging 311
- Switching mechanism 217
- Syntactic foams 369

**T**

Table for the thermoformer 67  
 Teflon 370  
 Temperature control 150, 160  
 Temperature control with ceramic heat elements 161  
 Temperature differential in semi-finished product 131  
 Temperature gradient 38  
 Temperature profile relative to semi-finished product gauge 146  
 Temperature reduction 161  
 Temperature stabilisation 151  
 Tension in the semi-finished material 331  
 Thermoforming 1–3  
 Thermoforming process 177  
 Thermoplastic material of reference 39  
 Thickness tolerances 62, 63  
 Three-dimensional cuts 275  
 Tilting motion 216  
 Tilt mechanism technology 216  
 Tolerances 62  
 Tool base 403  
 Tool configurations 204, 205  
 Tool set 28  
 Tool venting 364  
 Toothed chains 203  
 Total array control 171  
 Total hardness 409  
 Total shrinkage 45  
 TPO 85  
 TPS 110  
 Transparent 229, 377  
 Transparent cups 233  
 Transverse row control 172

Tray tool 391–393  
 Trimless 332  
 Twin-chamber method 190  
 Twinsheet forming 191, 379

**U**

Undercuts 375  
 Undulations 40  
 Universal flow chart 207  
 Universal tool 350  
 Upholder 30  
 UV resistance 117

**V**

Vent cross-sections 33  
 Visco-elastic 60

**W**

Wall-thickness distribution 56  
 Welded seam 380  
 Welding 276  
 Whole number of advance-feed cycles 140  
 Wind deflector 239  
 Windows 238  
 With protective film 231  
 Wooden tools 339, 360  
 Wrapping 325  
 Wrinkle formation 23, 57  
 Wrinkle formation in negative forming 27  
 Wrinkle formation in positive forming 24  
 Wrinkle formation on surfaces 27