

# Lösungen der Übungsaufgaben

1.1:

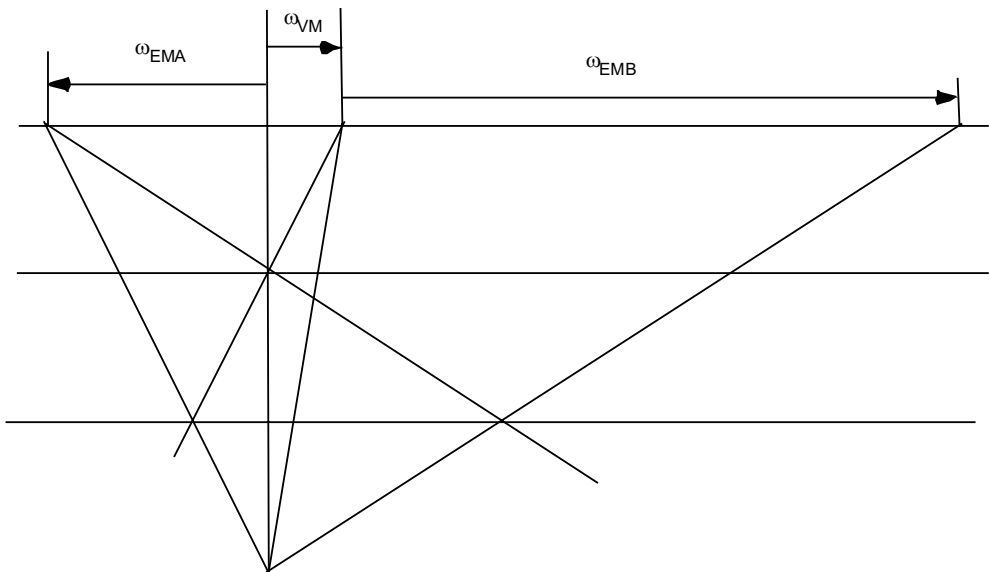

1.2:

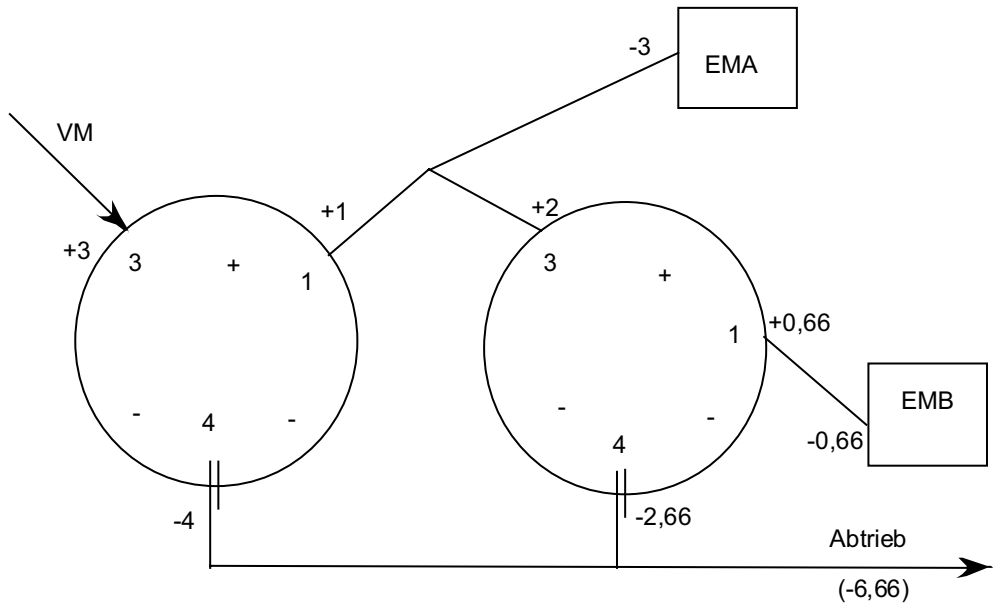

Übersetzung  $i = 2,22$

1.3:

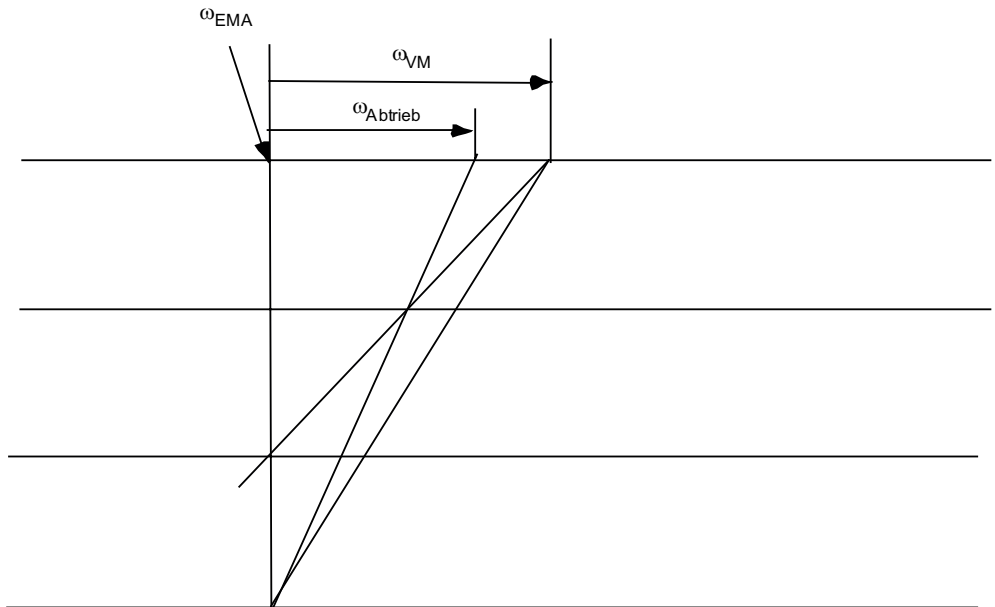

1.4:

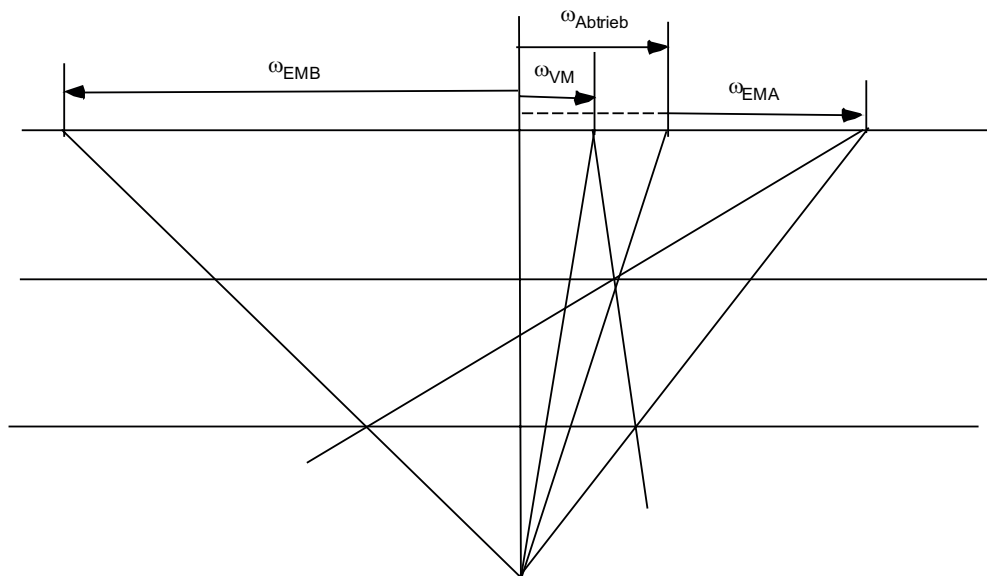

1.5:

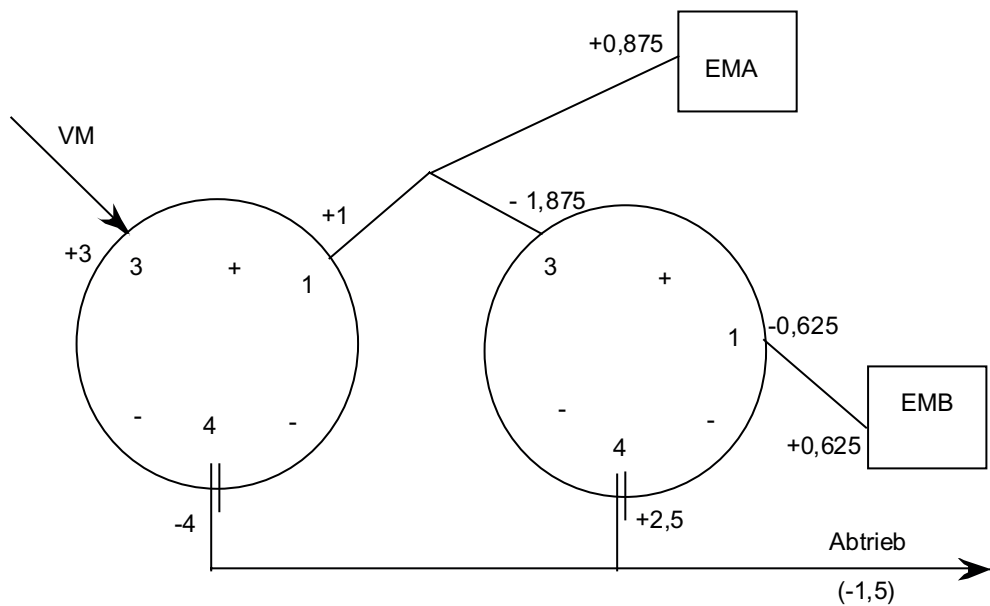

1.6:

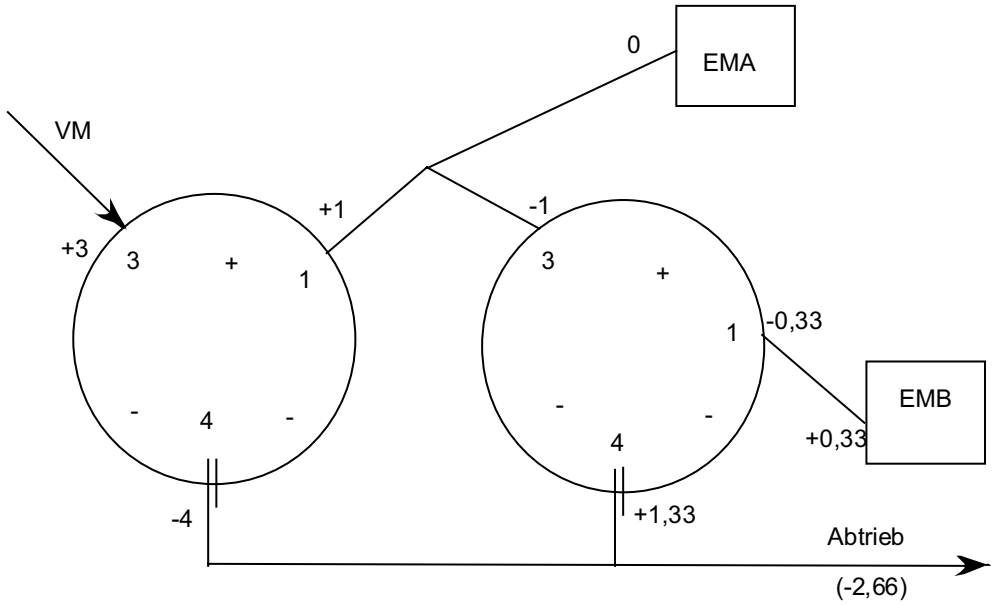

Übersetzung  $i = 0,89$

1.7:

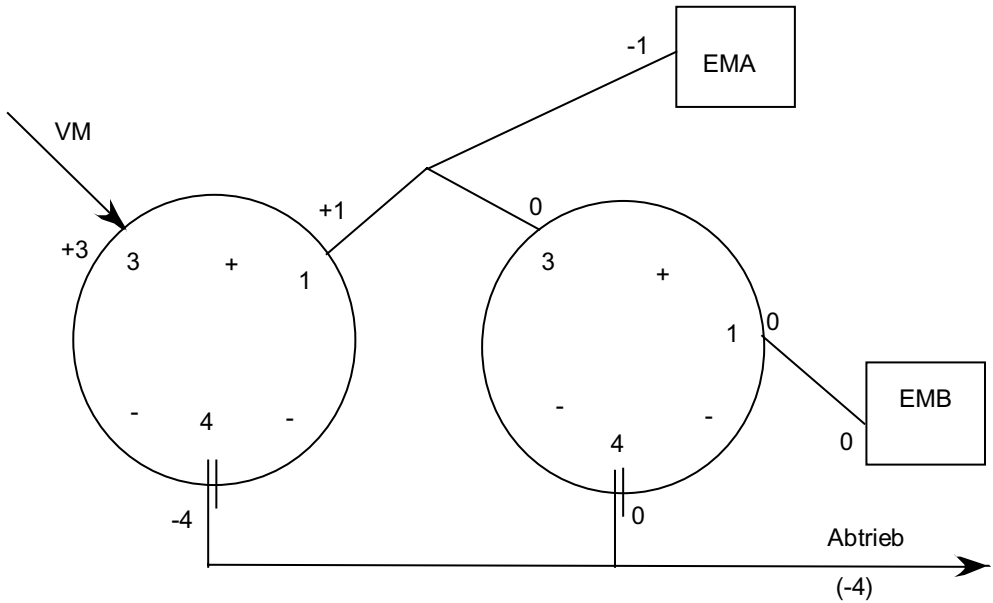

Übersetzung  $i = 1,33$

## 2.1:

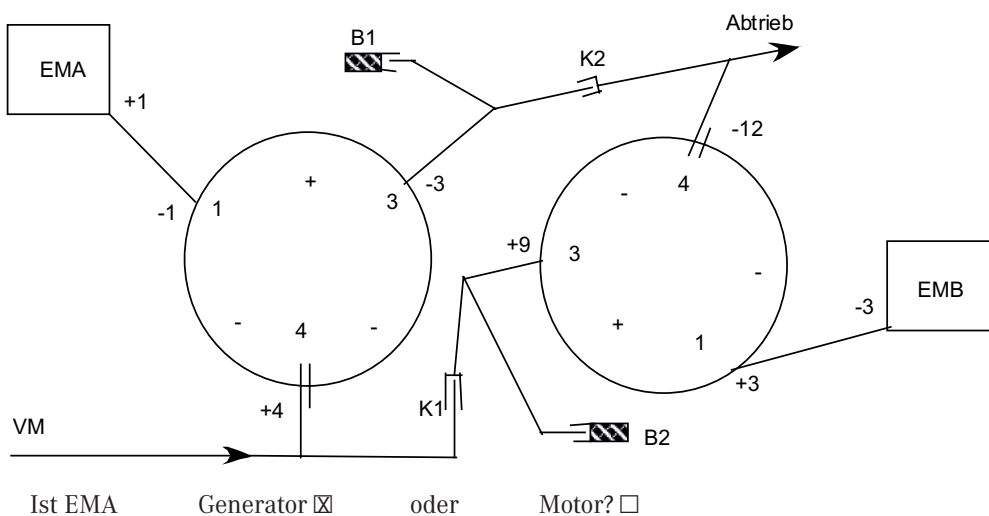

## 2.2:

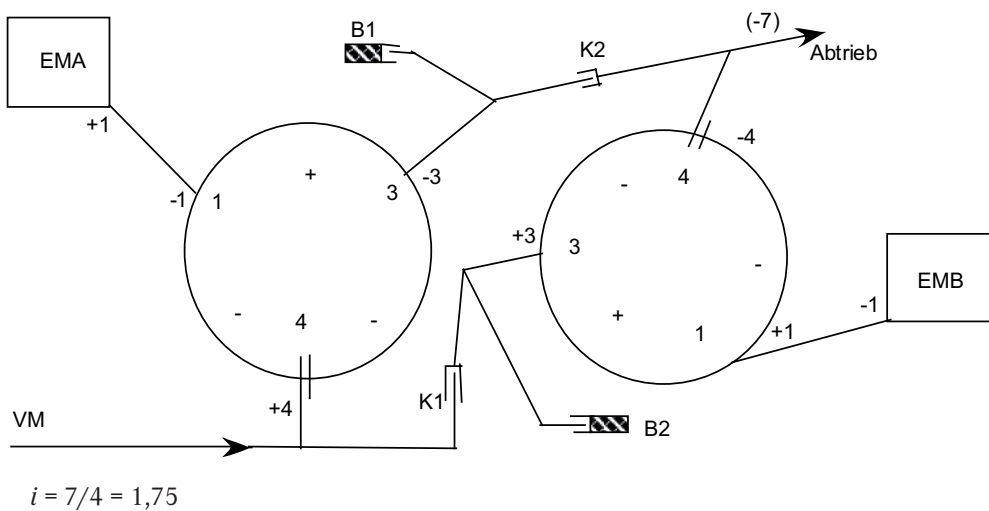

2.3:

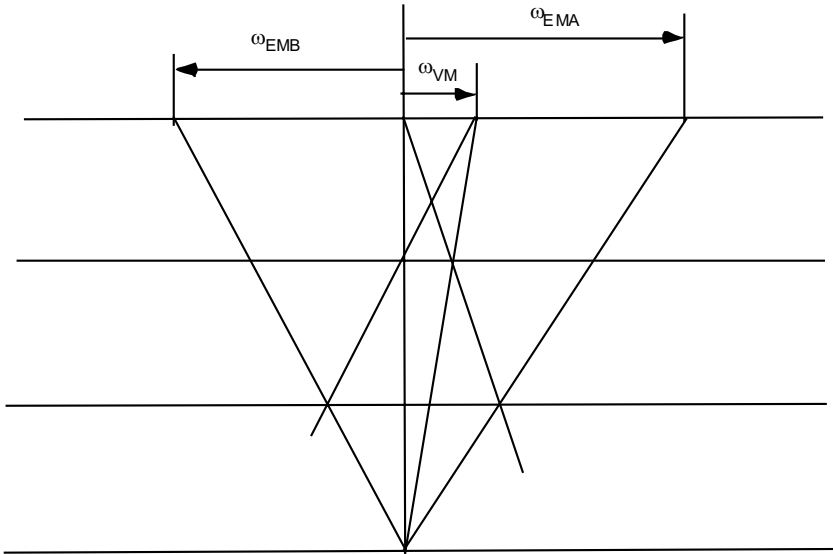

2.4:

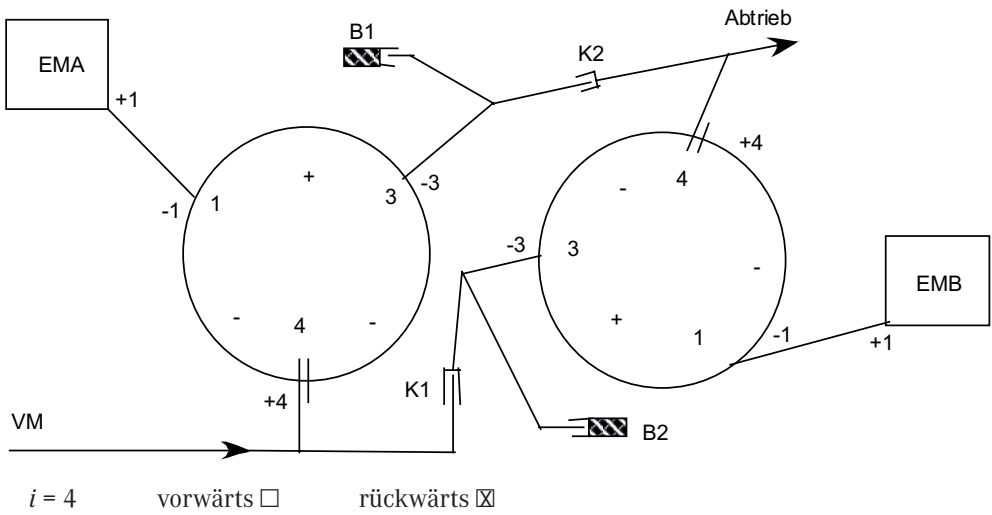

## 2.5:

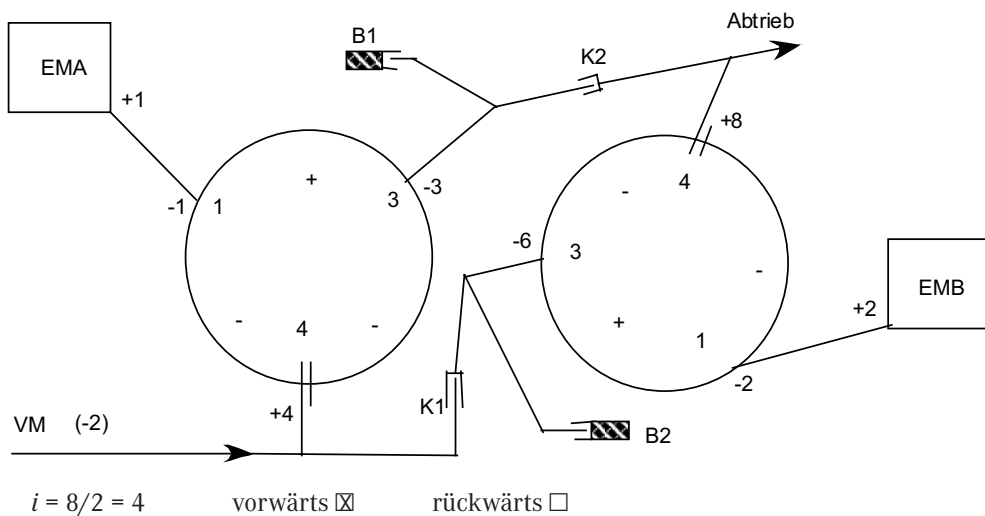

## 3.1:

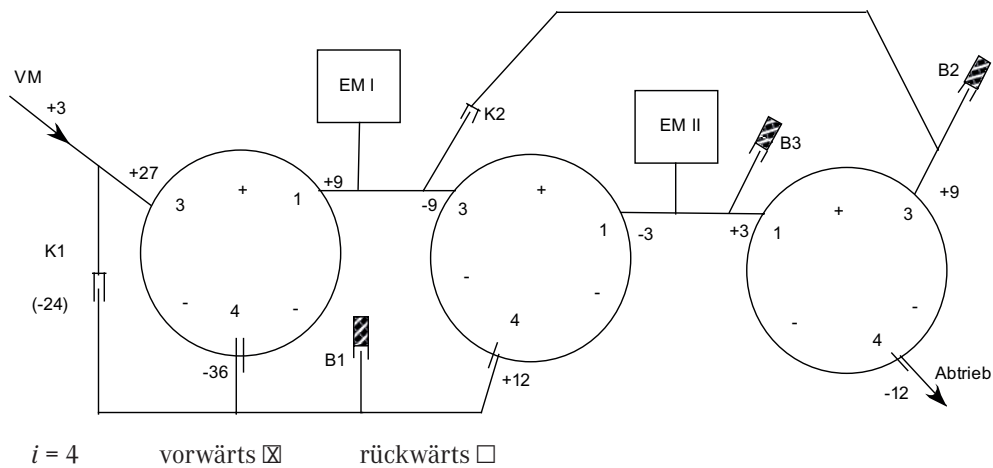

3.2:

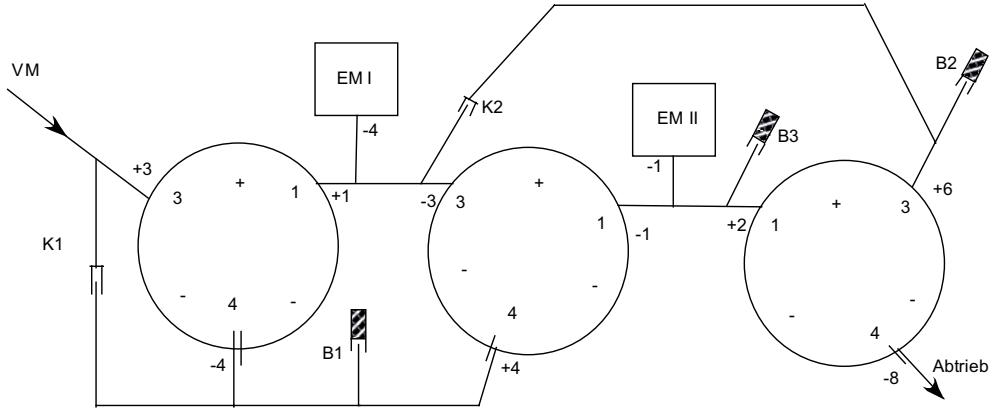

$i = 8/3 = 2,666$

vorwärts

rückwärts

3.3:

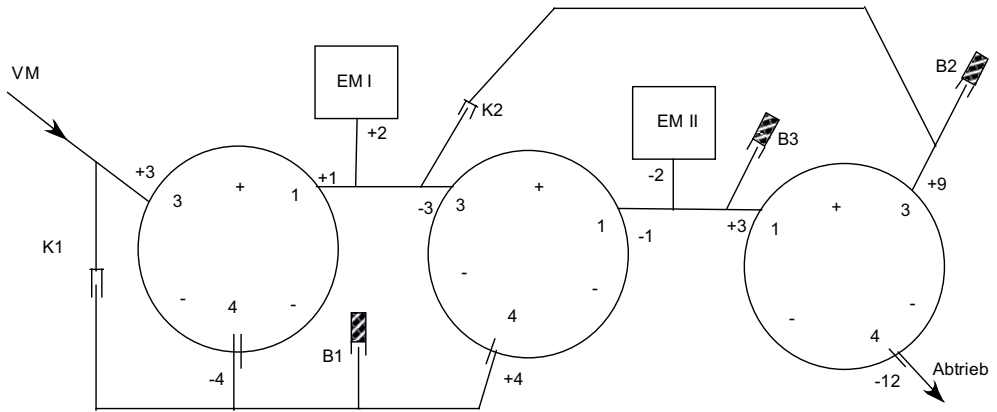

$i = 4$

vorwärts

rückwärts



## 4.1:

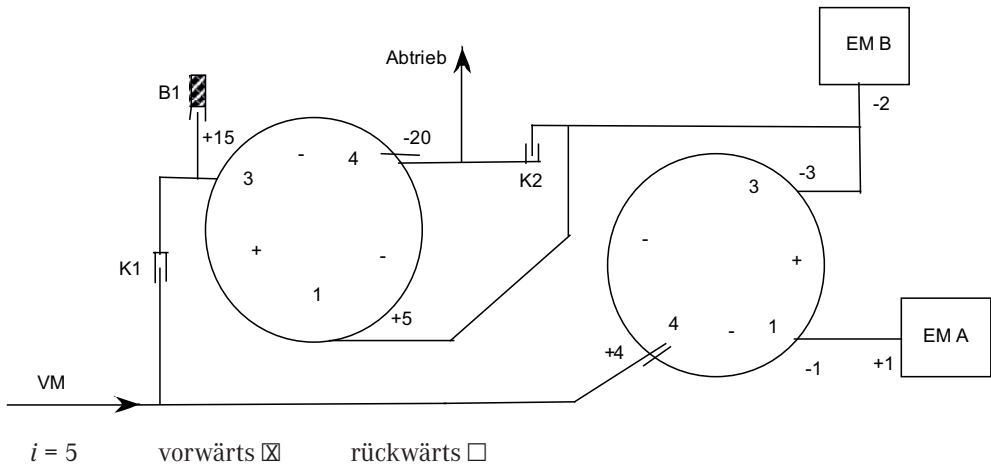

## 4.2:

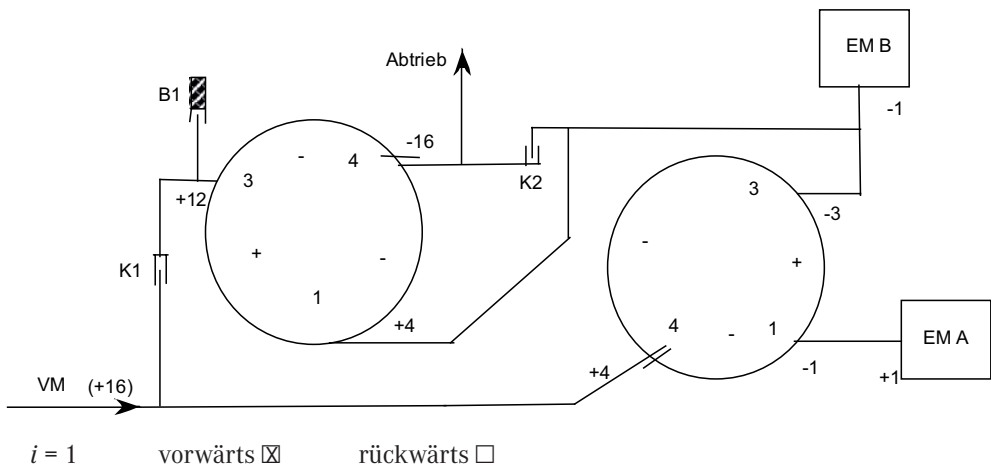

4.3:

